

NYOTA 115

Electro-mechanical sliding gate operator

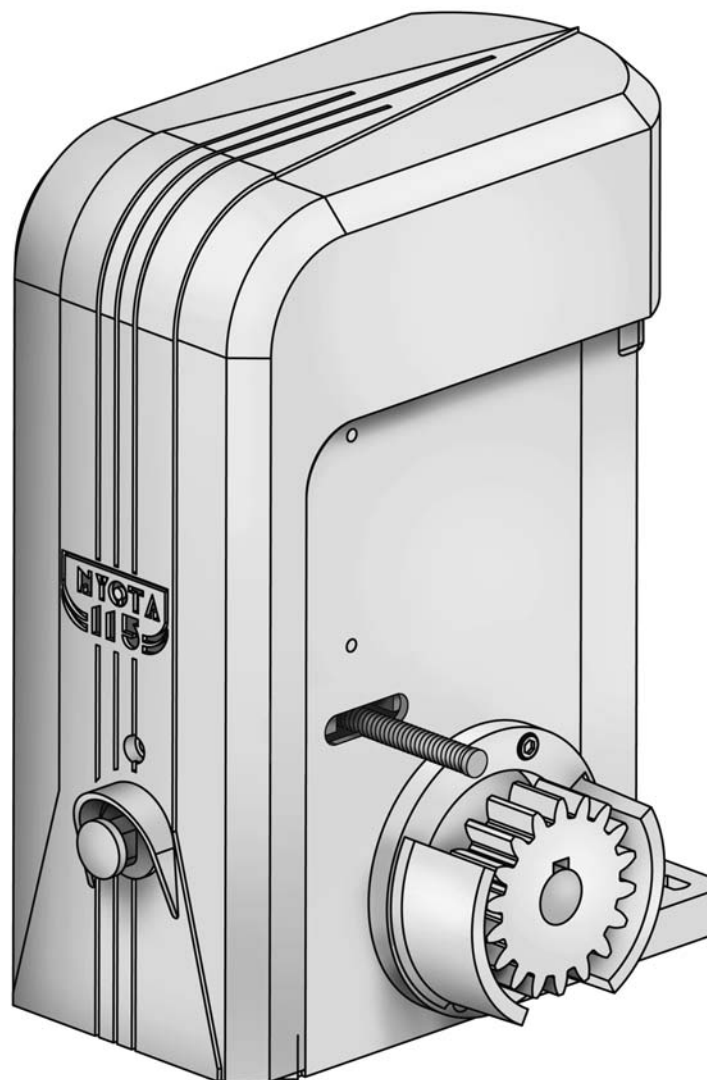

CE

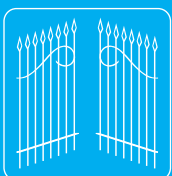

FADINI
the gate opener
Made in Italy

Instruction manual

GB

INSTRUCTIONS FOR THE INSTALLATION OF THE AUTOMATION

NYOTA 115

FOR A CORRECT INSTALLATION AND GOOD PERFORMANCE OF NYOTA 115 READ THE INSTRUCTIONS THAT ARE OUTLINED IN THIS MANUAL AND KEEP TO THE DIAGRAMS.

Nyota 115 is an extremely versatile system for sliding gates up to 1'200 Kg gate weight. It is available in 0.37 KW (0.5 HP) single- and three-phase versions and 0.73 KW (1.0 HP) single and three-phase versions.

It is a strong and reliable automation. It has a torque control device that can be manually adjusted; worm and gear are made of bronze and steel and are supported by bearings, all these parts in an oil bath. A manual overriding system allows manual operations of the gate in emergency events like power failure.

POINTS TO CHECK WITH THE GATE

Check that the gate track is well fixed to a solid foundation to prevent deformation which would result into an unbalanced travelling of the gate. **IMPORTANT:** Make sure that gate stops are fixed in the fully open and fully closed gate positions so that the gate does not over travel the permitted limit and go out of the upper guide.

IMPORTANT: Make sure that, once at the end of the permitted travel, the gate does not hit the gate posts or specially fitted gate stops to avoid damages to its structure.

FITTING NYOTA 115 ONTO THE FIXING BASE PLATE

- The first operation is to fix the **fixing bracket** to the ground and make sure that it is perfectly **levelled**. Fixing distances are as indicated (pic.1). Fixing is by setting the plate into a concrete foundation.
- Remove the **cover** of NYOTA 115 by loosening the fixing **screw-A** (or by the optional key): pull the cover outwards and almost simultaneously upwards (pic.2).
- NYOTA 115 is fixed to the **bracket** by four **screws-B** (pic.3)

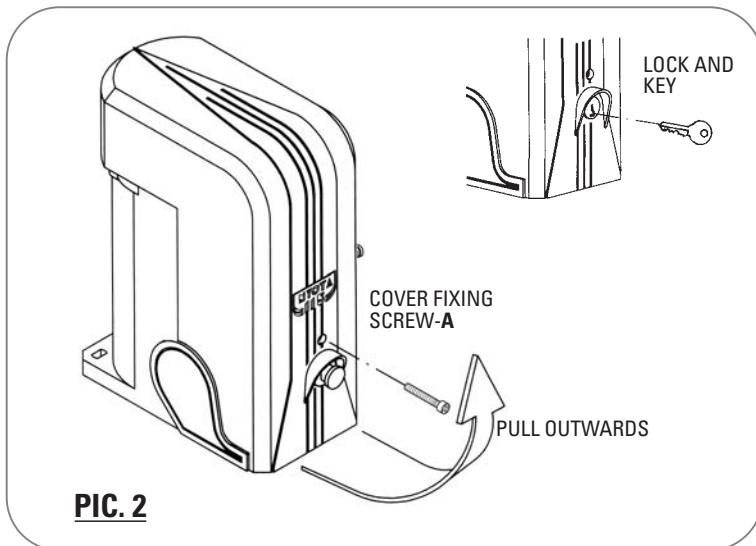
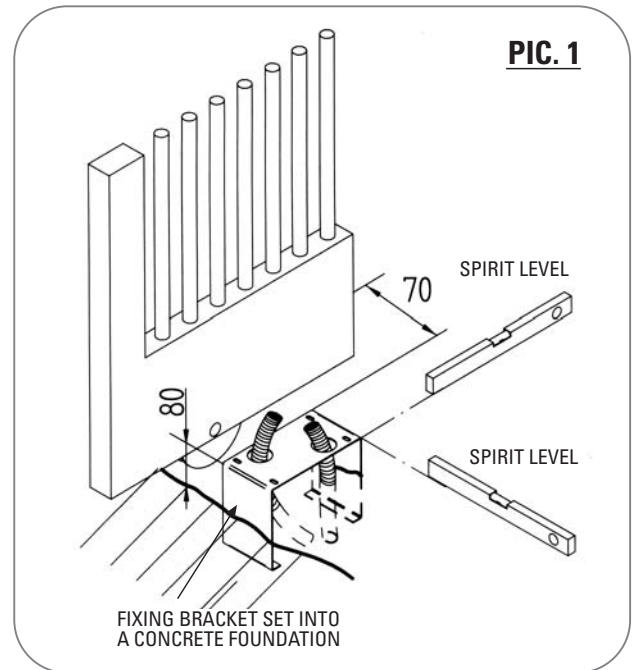

RACK FITTING OPERATIONS

IMPORTANT: When installing NYOTA 115 it is recommended to insert **2 mm shims** between the fixing bracket and the NYOTA 115 base plate (NYOTA 115 perfectly levelled) before welding the rack to the gate, so that the rack and gear mesh each other with an adequate clearance after that the shims have been removed (pic.3).

- Temporarily fix NYOTA 115 onto the fixing bracket, perfectly levelled, by the four fixing screws-B (pic.3).

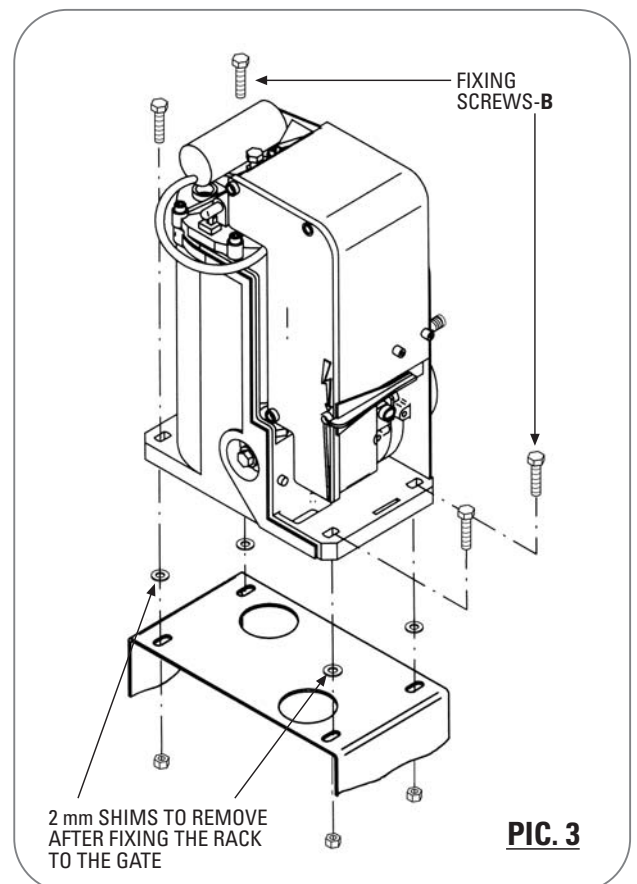

- How to **release** NYOTA 115 from the gate and disconnect the driving gear: remove the cover (pic.2) and unscrew the hexagonal screw (by 1 or 2 turns maximum) by the **release spanner** E 13 supplied with the equipment (pic.4).

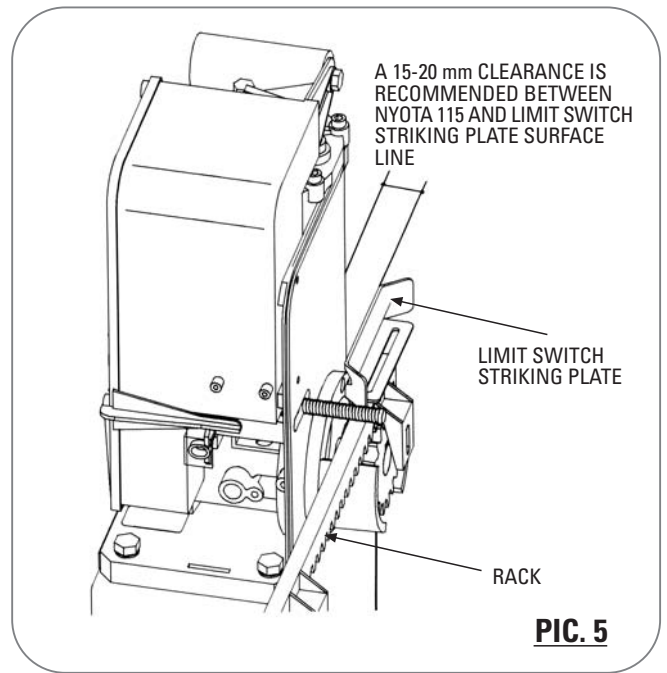
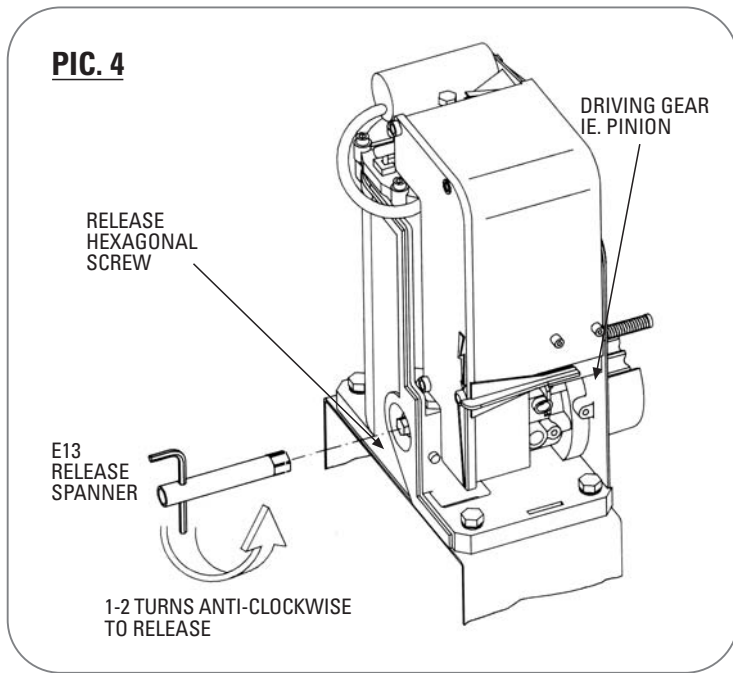

- This explains how to fix the **rack**. Release the system by the provided **E 13 spanner** so that the **driving gear** of NYOTA 115 can run idle (pic. 4). (The gate can be freely moved by hand, the operator Nyota 115 standing in idle position).
 - Temporarily **clamp** the rack to the gate so that it can adequately mesh the **driving gear** (The 2 mm shims still fitted between Nyota 115 base plate and the fixing bracket). Use a spare rack bar to make sure that junctions have the same rack pitch (pic.7).
 - Spot weld an **angle bracket** to the gate first, then the **rack** in the same way (if the welding type has been supplied), or fix it to the gate **by screws** (if either the nylon or galvanized type with fixing eyes has been supplied) (pic.6).
- IMPORTANT:** Before welding or fixing permanently any component, make sure that the rack can mesh the **driving gear** of NYOTA 115 so that the whole system can be smoothly run by hand the full gate travel open and close without any friction, Nyota 115 still in idle position.
- Remove the **2 mm shims** only after having fixed the rack. An adequate clearance between rack and gear has thus been achieved (pic.3).

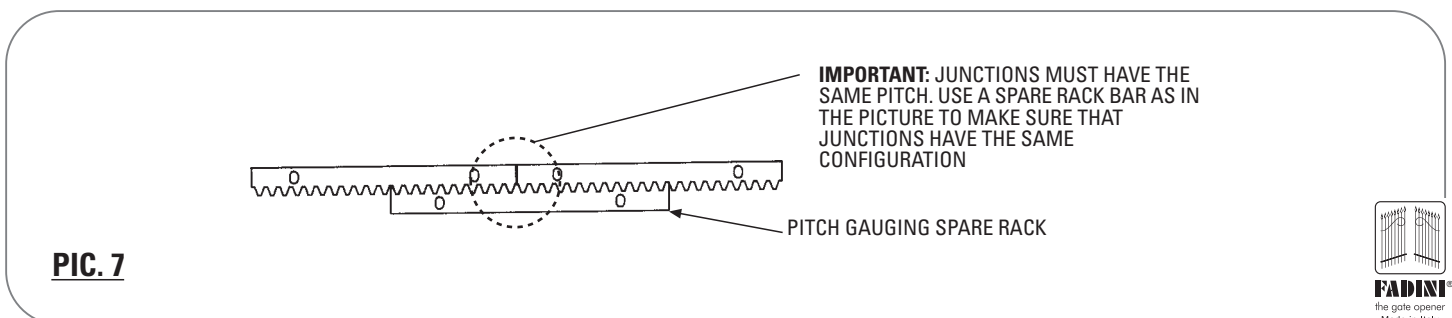
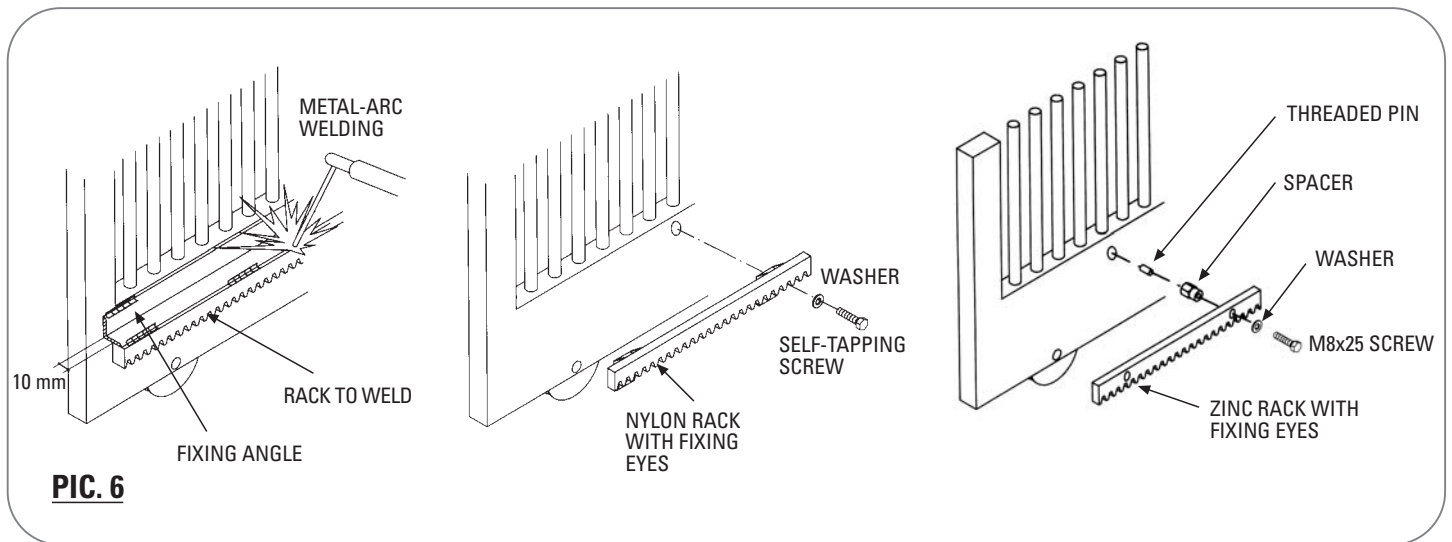

LIMIT SWITCH STRIKING PLATES. FITTING INSTRUCTIONS

- Fix the **limit switch striking plates** as shown in the diagram: the distance between NYOTA 115 and the **striking plate front surface line** must be **15 - 20 mm** approx. (pic. 5).

IMPORTANT: the gate must stop before hitting the gate post or special gate stops to prevent any damage to its structure.

ELECTRICAL CONNECTIONS

to the electronic control panel:

- **Voltage supply, electric motor, flashing lamp** require 1.5 mm² cables, which must not exceed a 50 m distance. For greater distances the recommended cable square section is 2 mm² (pic.8).

- **Limit switches, photocells, keyswitch, push button switch and accessories:** 1 mm² cables can be used for these items (Pic.8).

- The safety **pneumatic edge** is to be fitted to the gate edge and is connected to the control box by a cable to be automatically rewound to take up the slack. A **remote-controlled switch** can be fitted instead, **series** connected with the **limit switch** or the **photocell receiver**.

- The electronic control panels type ELPRO 10 PLUS CEI and ELPRO 14 PLUS (for double bi-parting sliding gates only) are pre-set for all required operations, automatic or semi-automatic, and are fitted with line relays and fault-detecting led indicators (pic.10 and 12).

IMPORTANT: Before connecting the system to the mains, position the **voltage change-over switch** to coincide with the site specifications (either 230 V or 400 V); the switch is fitted onto the main boards of ELPRO 10 PLUS CEI and ELPRO 14 PLUS (Pic.10 and Pic.12). An option is available where the control panel ELPRO 12 PLUS is incorporated in the operator (230 V single-phase only); for the electrical connections follow the diagram pic. 11 (n.w. the limit switches and the electric motor are pre-wired).

- **IMPORTANT:** Fit the system with a **junction box** where all cables can be pre-terminated.

PIC. 8

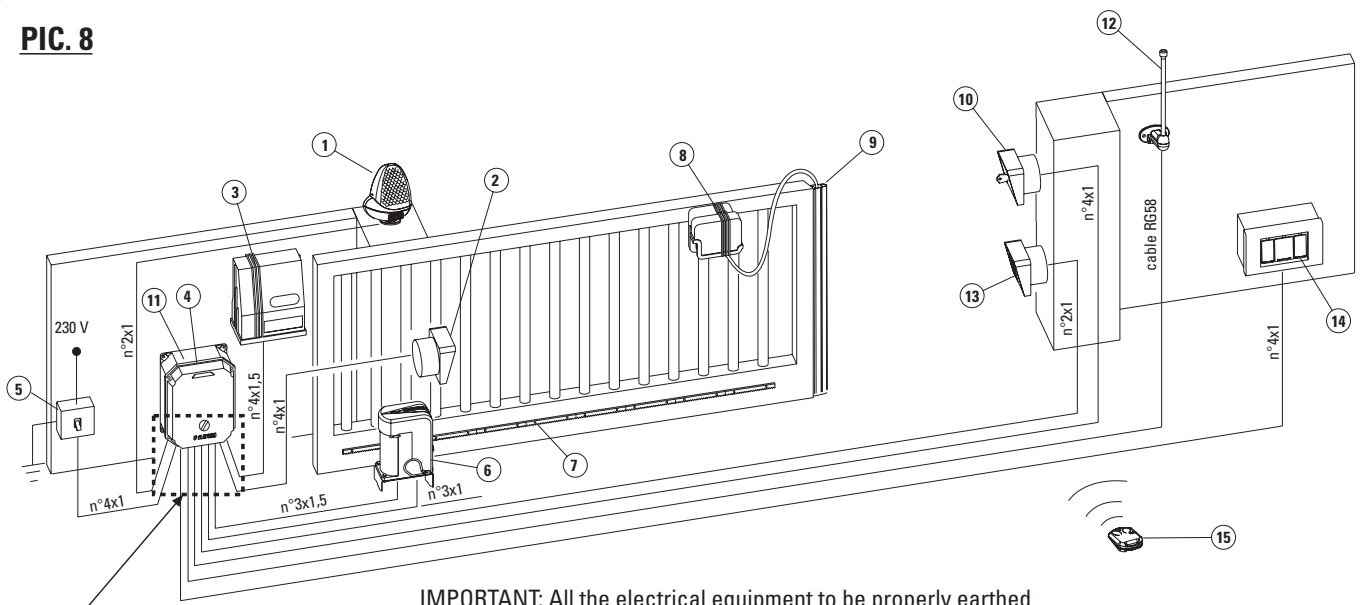

JUNCTION BOX WHERE ALL CABLES ARE PRE-TERMINATED

IMPORTANT: All the electrical equipment to be properly earthed

- | | |
|---|--|
| 1) FLASHING LAMP MIRI 4 | 8) REMOTE-CONTROLLED SWITCH TRANSMITTER CRUASTRO |
| 2) PHOTOCELL RECEIVER POLO 44 | 9) SAFETY EDGE |
| 3) REMOTE-CONTROLLED SWITCH RECEIVER CRUASTRO | 10) KEYSWITCH PRIT 19 |
| 4) CONTROL PANEL ELPRO 10 PLUS CEI | 11) PLUG-IN RADIO RECEIVER ASTRO 43 |
| 5) 0.03 A DIFFERENTIAL MAGNETIC-THERMAL CIRCUIT BREAKER | 12) AERIAL BIRIO A8 |
| 6) OPERATOR NYOTA 115 | 13) PHOTOCELL PROJECTOR POLO 44 |
| 7) RACK | 14) PUSH BUTTON SWITCH PULIN 3 |
| | 15) TRANSMITTER ASTRO 43/2 SMALL |

- NYOTA 115 is fitted with an **external safety microswitch (1)** which disconnects the low voltage circuit whenever the operator cover is removed; on request an extra **internal safety microswitch (2)** can be fitted to ELPRO 12 PLUS control box in order to disconnect the 230 V supply when the lid of the control box is removed. To ensure the correct functioning of the system in case the a.m. parts are removed, make sure that they are put back to the original position to allow the respective contacts to be properly closed (pic.9).

PIC. 9

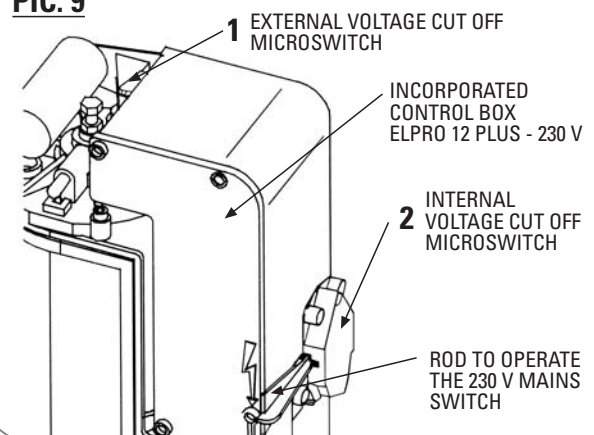

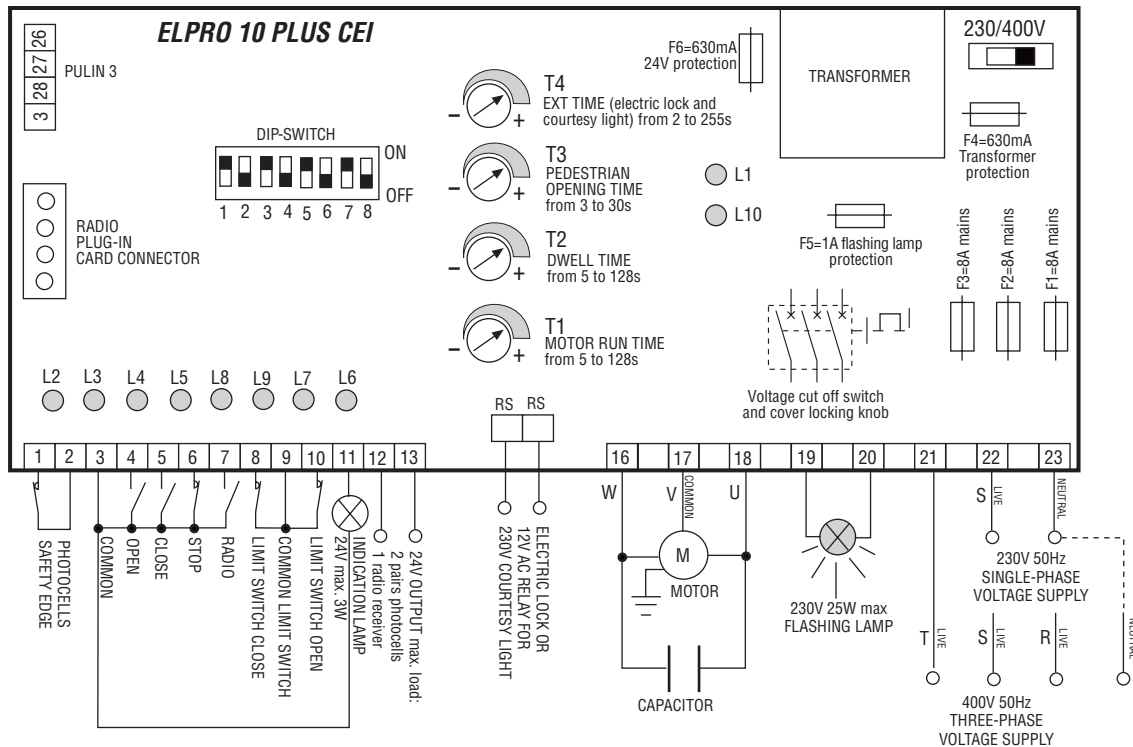

PIC. 10

General description: the electronic control panel Elpro 10 Plus CEI, new generation, is designed to operate sliding gates. Power supply is 230/400V single-phase and three-phase. Built in full compliance with BT 93/68/CE Low Voltage and EMC 93/68/CE Electro-Magnetic Compatibility Regulations. Fitting operations are recommended by a qualified technician in conformity to the existing safety standards. The manufacturing company declines any responsibility for incorrect handling and application; also, it reserves the right to change or update the control panel any time. **Failure to follow installation regulations may result in serious damage to property and persons.**

PLEASE NOTE:

- The control panel must be installed in a sheltered, dry place, inside the box provided with it.
- Make sure that the power supply to the electronic programmer is $230V \pm 10\%$ or $400V \pm 10\%$
- Make sure that the power supply to the Electric Motor is $230V \pm 10\%$ or $400V \pm 10\%$
- For distances of over 50 metres we recommend using electric cables with bigger sections.
- Fit the mains to the control panel with a 0.03A high performance circuit breaker.
- Use 1.5 mm^2 section wires for voltage supply, electric motor and flashing lamp. Maximum recommended distance 50 m. Use 1 mm^2 section wires for limit switches, photocells, push-buttons/key-switch and accessories.
- Bridge terminals 1 and 2 if no photocells are required.
- Bridge terminals 3 and 6 if no key- or push-button switches are required.

N.W: To fit extra accessories such as lights, CCTV etc. use only solid state relays to prevent damages to the microprocessor.

Dip-Switch:

- 1= ON. Photocells. Stop while opening
- 2= ON. Radio. No reversing while opening
- 3= ON. Automatic closing
- 4= ON. Preflashing activated
- 5= ON. Radio. Step by step. Stop in between
- 6= ON. Dead Man Control (Dip 4=OFF and Dip 3=OFF)
- 7= ON. No lamp on during dwell time
- 8= OFF. No function

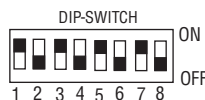
**In case of failure of the panel:**

- Make sure that the power supply to the electronic programmer is $230V \pm 10\%$ or $400V \pm 10\%$
- Make sure that the power supply to the Electric Motor is $230V \pm 10\%$ or $400V \pm 10\%$
- Check fuses
- Check photocells if contacts are normally closed
- Check all NC contacts
- Check that no voltage drop has occurred from the control panel to the electric motor

Led Status Indication:

- L1= 230V 50Hz power supply. A light
- L2= Photocells, if obstructed light goes off
- L3= Open. A light whenever an Open pulse is given
- L4= Close. A light whenever a Close pulse is given
- L5= Stop. It goes off on pulsing Stop
- L6= Radio. It goes on by pressing a transmitter button
- L7= Gate Status; it flashes on gate opening
- L8= Limit switch Close; off when gate is closed
- L9= Limit switch Open; off when gate is open
- L10= It stays on for a time equal to the time set on T4

LOW VOLTAGE ELECTRICAL CONNECTIONS

Photocells and Safety Edge:

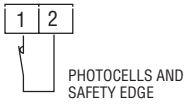

DIP-SWITCH 1:

- ON: Photocells stop gate while opening, reverse it on closing once obstacle is removed
- 1 OFF: Photocells do not stop gate while opening, reverse it on closing in case of an obstacle

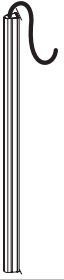

Button switch:

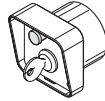
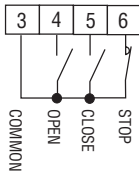

Limit switch:

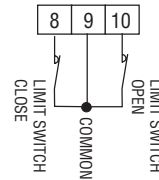

Radio Contact:

- Open/Close (Standard)
- Travel reversing on pulsing
- Step by step

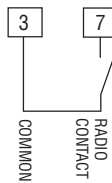

DIP-SWITCH 2 and 5 (NEVER set BOTH of them to ON at the same time):

- ON: Gate is not reversed while opening
- 2 OFF: Any pulse reverses the gate
- ON: Step by step. Stop in between
- 5 OFF: Standard operating mode

Push Button Switch Pulin3:

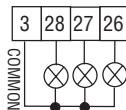

Led to indicate status of Open Stop - Close switches

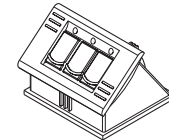
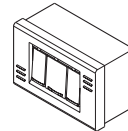

24V 3W Indication Light:

- Light **ON** = Open gate
- Light **OFF** = Closed gate
- Flashing (**fast**) **0.5s** = Closing gate
- Flashing (**normally**) **1s** = Opening gate
- Flashing (**slowly**) **2s** = gate is stopped

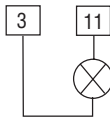

Courtesy light:

Connect a 12VAC Relay (T4 Trimmer Time from 2s to 255s) to operate a 230V lamp



Electric lock:

Set the T4 Trimmer Time to the lowest value. The electric lock is excited for 2 seconds

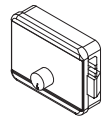

ELECTRIC POWER CONNECTIONS

Single- (230V) and Three-phase (400V) Motors:

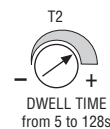
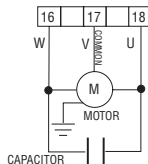

Flashing lamp:

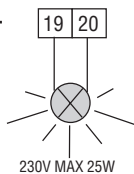

DIP-SWITCH 4 and 7:

- ON: Pre-flashing
- OFF: No pre-flashing
- 4
- ON: Lamp is not operating during Dwell Time. Automatic Mode.
- 7 OFF: It flashes during Dwell Time. Automatic Mode.

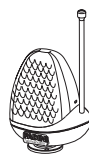

Power supply:

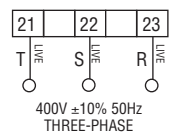
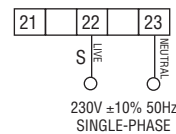

OPERATING MODES**Automatic / Semiautomatic:**

Automatic Operation: any pulse opens the gate, the gate stays open as long as the Dwell time expires as set by T2 trimmer, then it closes automatically, no pulsing is required.

Semi-automatic Operation: any pulse opens the gate that stays open. A second pulse to Close is required for the gate to close.

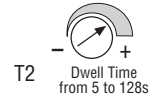

DIP-SWITCH 3

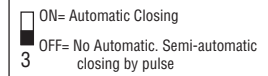
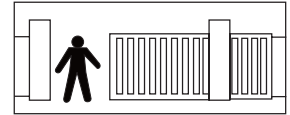
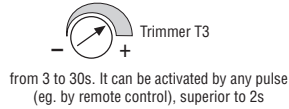
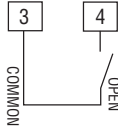
**Pedestrian Opening:****Hold on switched (Deadman) control:**

Open and Close operations are achieved "by holding a switch on" (no relay self-holding is involved) therefore a physical attendance is required to keep the gate opening or closing until either the button or key is released.

DIP-SWITCH 6

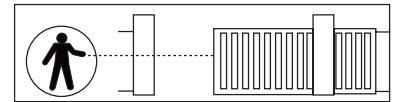
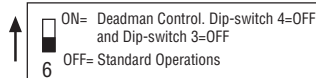
**Remote Controlled Operations Excluded during Dwell Time on Automatic Mode:**

With this setting it is not possible to operate the gate by remote control during the dwell time on automatic mode. DIP-SWITCH 2=ON, 3=ON and 5=ON

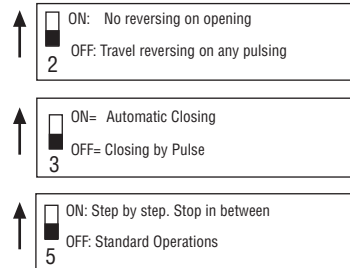
**Time clock installation:**

How it works: Set the clock to the required time. On the pre-set time the gate is automatically opened and held open. Any further pulsing (even by remote control) is not accepted by the system until the time pre-set by the clock has expired. On expiring and after the pre-set dwell time the gate is closed automatically.

T3 trimmer on to zero, Dip-Switch 3=ON.

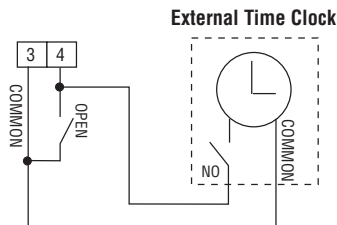

DIP-SWITCH N°3=ON Automatic Closing

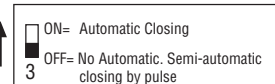

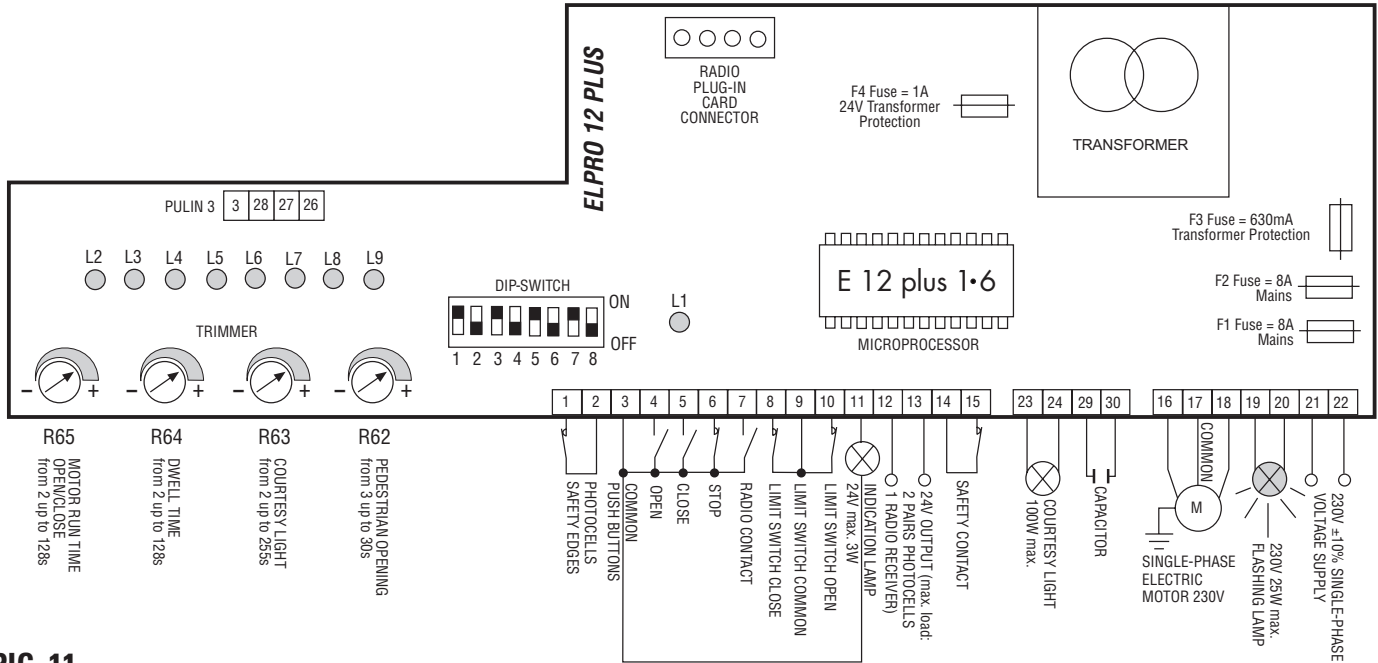

PIC. 11

General description: the electronic control panel Elpro 12 Plus, new generation, is designed to operate the sliding gate operator Nyota 115. Power supply is 230V 50Hz single-phase. Built in full compliance with BT 93/68/CE Low Voltage and EMC 93/68/CE Electro-Magnetic Compatibility Regulations. Fitting operations are recommended by a qualified technician in conformity to the existing safety standards.

The manufacturing company declines any responsibility for incorrect handling and application; also, it reserves the right to change or update the control panel any time.

Failure to follow installation regulations may result into serious damage to property and persons.



PLEASE NOTE:

- The control panel must be installed in a sheltered, dry place, inside the box provided with it.
- Make sure that the power supply to the electronic programmer is 230V \pm 10%
- Make sure that the power supply to the Electric Motor is 230V \pm 10%
- For distances of over 50 metres we recommend using electric cables with bigger sections.
- Fit the mains to the control panel with a 0.03A high performance circuit breaker.
- Use 1.5mm² section wires for voltage supply, electric motor and flashing lamp. Maximum recommended distance 50m.
- Use 1mm² section wires for limit switches, photocells, push-buttons/key-switch and accessories.
- Bridge terminals 1 and 2 if no photocells are required.
- Bridge terminals 3 and 6 if no key- or push-button switches are required.

N.W: To fit extra accessories such as lights, CCTV etc. use only solid state relays to prevent damages to the microprocessor.

Dip-Switch:

- 1= ON. Photocells. Stop while opening
- 2= ON. Radio. No reversing while opening
- 3= ON. Automatic closing
- 4= ON. Preflashing activated
- 5= ON. Radio. Step by step. Stop in between
- 6= ON. Dead Man Control (Dip 4=OFF and Dip 3=OFF)
- 7= ON. No lamp on during dwell time
- 8= OFF. No function

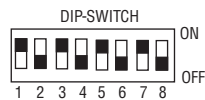

Led Status Indication:

- L1= 230V 50Hz power supply. A light
- L2= Photocells, if obstructed light goes off
- L3= Open. A light whenever an Open pulse is given
- L4= Close. A light whenever a Close pulse is given
- L5= Stop. It goes off on pulsing Stop
- L6= Radio. It goes on by pressing a transmitter button
- L7= Gate Status; it flashes on gate opening
- L8= Limit switch Close; off when gate is closed
- L9= Limit switch Open; off when gate is open

In case of failure of the panel:

- Make sure that the power supply to the electronic programmer is 230V \pm 10%
- Make sure that the power supply to the Electric Motor is 230V \pm 10%
- For distances of over 50 metres we recommend using electric cables with bigger sections.
- Check fuses
- Check photocells if contacts are normally closed
- Check all NC contacts
- Check that no voltage drop has occurred from the control panel to the electric motor



FADINI
The gate opener
Made in Italy

Drwg. No. 4086



LOW VOLTAGE ELECTRICAL CONNECTIONS

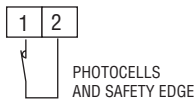

DIP-SWITCH 1:

- ON: Photoceils stop gate while opening, reverse it on closing once obstacle is removed
- OFF: Photoceils do not stop gate while opening, reverse it on closing in case of an obstacle

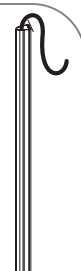
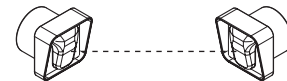

Button switch:

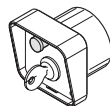
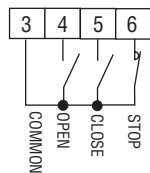

Limit switch:

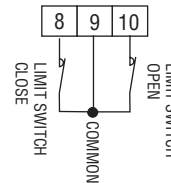

Radio Contact:

- Open/Close (Standard)
- Travel reversing on pulsing
- Step by step

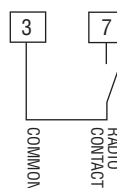

DIP-SWITCH 2 and 5 (NEVER set BOTH of them ON at the same time):

- ON: Gate is not reversed while opening
- OFF: Any pulse reverses the gate

- ON: Step by step. Stop in between
- OFF: Standard operating mode

Push Button Switch Pulin 3:

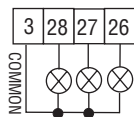

Led to indicate status of Open - Stop - Close switches

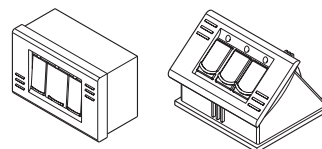

24V 3W Indication Light:

- Light **ON** = Open gate
- Light **OFF** = Closed gate
- Flashing (**fast**) **0.5s**= Closing gate
- Flashing (**normally**) **1s**= Opening gate
- Flashing (**slowly**) **2s**= gate is stopped

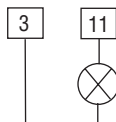

Safety Contact:

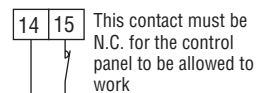

This contact must be N.C. for the control panel to be allowed to work

ELECTRICAL POWER CONNECTIONS

Capacitor and Single-phase Motor (230V):

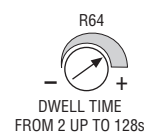
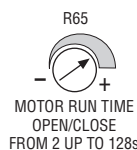
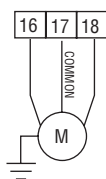
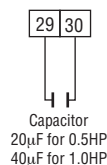

Flashing lamp:

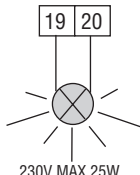

DIP-SWITCH 4 and 7:

- ON: Pre-flashing
- OFF: No pre-flashing

- ON: Lamp is not operating during Dwell time. Automatic mode.
- OFF: It flashes during Dwell Time. Automatic Mode.

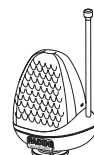

Power supply:

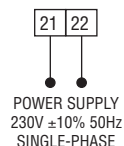

Courtesy Light 230V max. 100W:

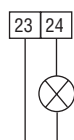

OPERATING MODES

Automatic / Semiautomatic:

Automatic Operation: any pulse opens the gate, the gate stays open as long as the Dwell time expires as set by R64 trimmer, then it closes automatically, no pulsing is required.

Semi-automatic Operation: any pulse opens the gate that stays open. A second pulse to Close is required for the gate to close.

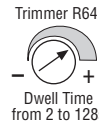

DIP-SWITCH 3

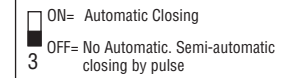

Pedestrian Opening:

Gate in fully closed position; an Open pulse opens the gate a span equals to the time set by Pedestrian Trimmer

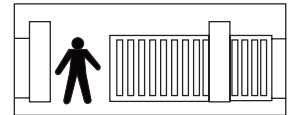
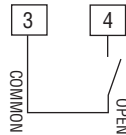

Hold on switched (Deadman) control:

Open and Close operations are achieved "by holding a switch on" (no relay self-holding is involved) therefore a physical attendance is required to keep the gate opening or closing until either the button or key is released.

DIP-SWITCH 6

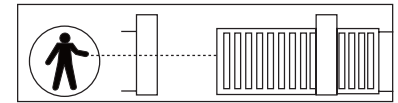
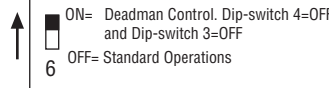

Time Clock Installation (Optional):

How it works: Set the clock to the required times. On the pre-set time the gate is automatically opened and held open. Any further pulsing (even by remote control) is not accepted by the system until the time pre-set by the clock has expired. On expiring and after the pre-set dwell time the gate is closed automatically. R62 trimmer on to zero, Dip-Switch 3=ON.

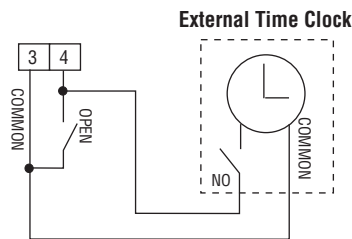

External Time Clock

DIP-SWITCH No.3=ON Automatic Closing

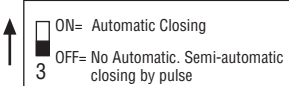

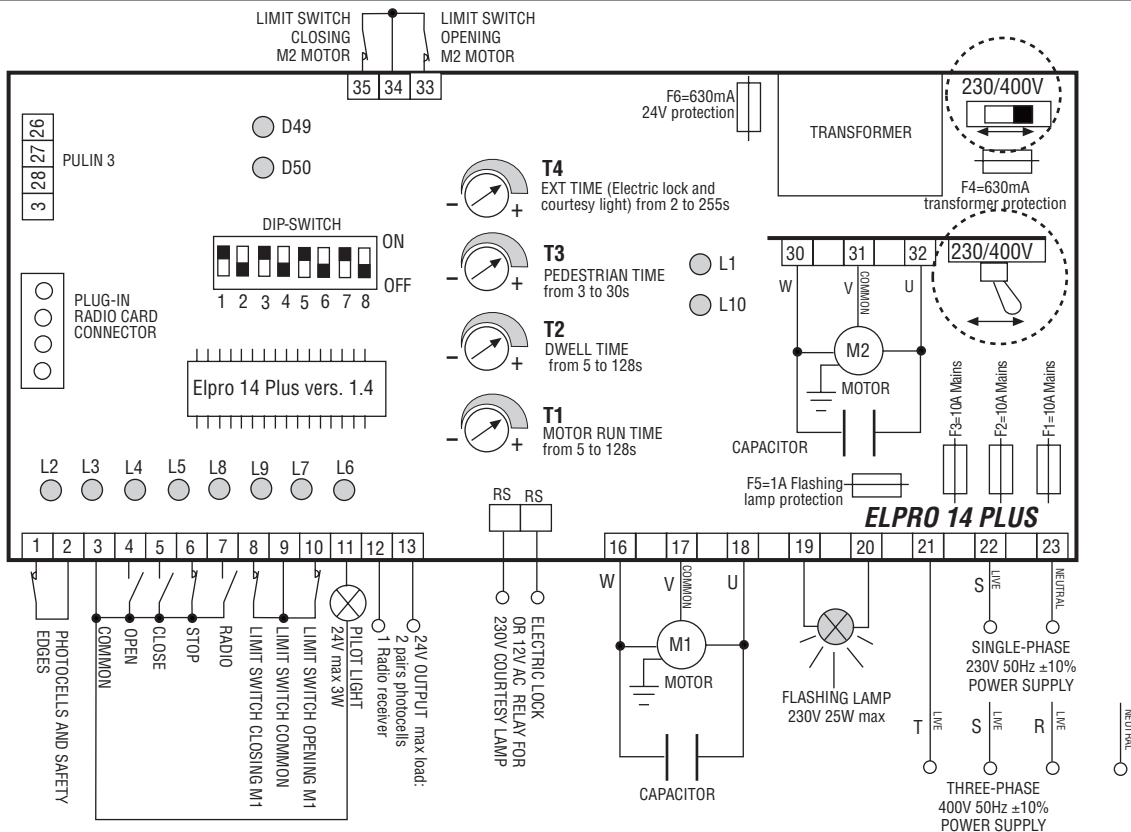

PIC. 12

General Description: Elpro 14 Plus is an electronic board incorporating a microprocessor to control single- and three-phase operators for bi-parting sliding gates. Power supply is 230V/400V $\pm 10\%$ 50Hz single- or three-phase. It is built in compliance with BT 93/68/CE Low Voltage norms and EMC 93/68/CE norms for the electro-magnetic compatibility. Installation is recommended by a qualified technician in observance of the existing regulations. Incorporated logic functions: automatic or semi-automatic operating modes, pre-flashing/no pre-flashing options, reversing/non reversing options by remote control, electric lock output, pedestrian mode, hold-on-switched (deadman) control, gate status indication by leds. The manufacturer declines any responsibility for incorrect handling and applications, and reserves the right to update the instructions and the control board without notice. **Failure to observe the installation instructions may result into serious damages to persons and properties.**

- IMPORTANT:**
- The control box is to be fitted in a sheltered, dry place inside a suitable enclosure
 - Fit the mains to the control box with a 0.03 A high performance, magnetic-thermal circuit breaker
 - Make sure that the power supplied to the board is 230V/400V $\pm 10\%$ 50Hz
 - For the power supply and the flashing lamp use 1.5 mm² wires up to 50 m distance; for the limit switches and the accessories use 1mm² wires
 - Bridge terminals 1 and 2 if no photocells are required
 - Bridge terminals 3 and 6 if no key- or button-switches are required
 - N.W: Should other applications be required such as light switching, CCTV, etc. use only solid state relays to prevent disturbances to the microprocessor.

Led Status Indication:

- L1** = Power supply 230V/400V $\pm 10\%$ 50Hz a light
- L2** = Photocells. If obstructed the led goes off
- L3** = Open. It illuminates when an Open pulse is given
- L4** = Close. It illuminates when a Close pulse is given
- L5** = Stop. It goes off when a Stop pulse is given
- L6** = Radio. It illuminates when the remote control is pulsed.
- L7** = Gate Status Indication. It flashes while gate is moving
- L8** = Limit switch Closing M1 motor. Off when gate is closed
- L9** = Limit switch Opening M1 motor. Off when gate is open
- L10** = It stays a light as long as the time set on T4 Trimmer
- D49** = Limit switch Closing M2 motor. Off when gate is closed
- D50** = Limit switch Opening M2 motor. Off when gate is open

Dip-Switch:

- 1= ON** Photocells stop gate on opening
- 2= ON** Radio. No gate reversing on opening
- 3= ON** Automatic Closing
- 4= ON** Pre-flashing in service
- 5= ON** Radio. Step by step, stop in between
- 6= ON** Deadman Control (Dip 4=OFF and Dip 3=OFF)
- 7= ON** Flashing lamp off on dwell time, automatic mode
- 8= OFF**, blank

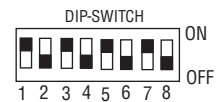

In case the automation fails to start:

- Check power supply to be 230V or 400V $\pm 10\%$ 50 Hz
- Check fuses
- Check photocells contacts to be normally closed
- Check all N.C. contacts
- Check that no voltage drop occurs between the board and the electric motor

LOW VOLTAGE ELECTRICAL CONNECTIONS

1 2 3 4 5 6 7 8 9 10 11 12 13

Photocells and Safety Edge:

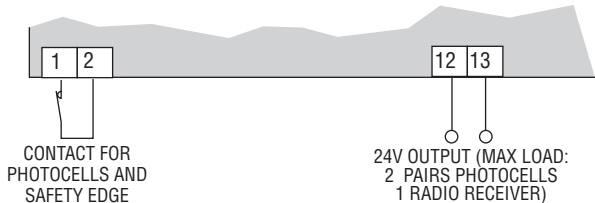

DIP-SWITCH 1:

- ON: Photocells stop gate on Opening and reverse it on Closing once obstacle is removed
- OFF: Photocells do not stop gate on Opening and reverse it on Closing if obstructed

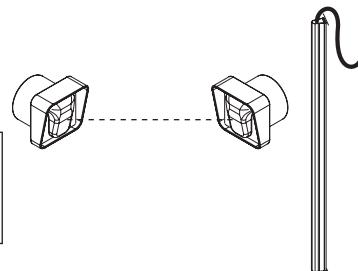

Keyswitch:

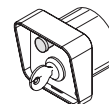
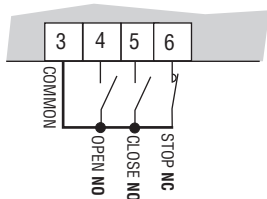

Limit switch:

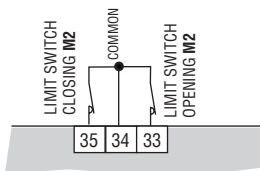
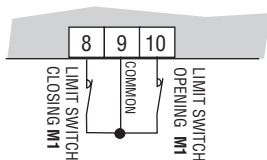

Radio Contact:

- Open/Close (standard)
- Any new pulse reverses gate travel
- Step by step

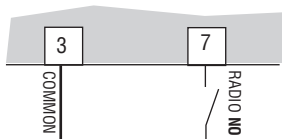

DIP-SWITCHES 2 & 5

(NEVER set both of them on to ON at the same time):

- ON: No reversing on Opening
- OFF: Reversing by any new pulse

- ON: Step by step. Stop in between
- OFF: Standard operating mode

Electric Lock:

Mechanical device to hold the gate in closed gate position.
Trimmer T4 to the lowest
Working Time: **2 seconds** anticipation of 100ms on gate starting.

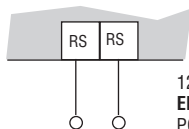

12V AC, 15VA OUTPUT
ELECTRIC LOCK
POWER SUPPLY

Trimmer T4
EXT TIME (Electric lock and Courtesy Light) from 2 to 255s
to the lowest

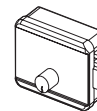

24V 3W Pilot Light for gate movement indication:

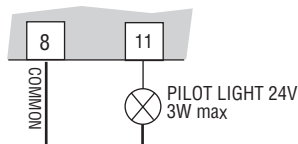

Light **On**= Gate Open. Passage allowed
Light **Off**= Gate Closed. Passage not allowed
Flashing **0.5s (fast)**= Gate Closing
Flashing **1s (normal)**= Gate Opening
With external clock: **2 short flashes** followed by a longer stop

Push Button unit Pulin3:

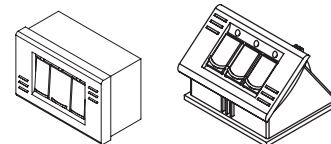
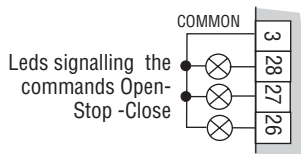

Courtesy light:

Connect a 12VAC relay (Trimmer T4 from 2s to 255s) to operate a 230V lamp

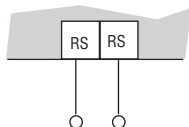

Trimmer T4
EXT TIME (Electric lock and Courtesy Light) from 2 to 255s



ELECTRIC POWER CONNECTIONS

16 17 18 19 20 21 22 23

Single- and three-phase motors:**Important:**

Depending on the site voltage requirements it is absolutely necessary to set both switches accordingly

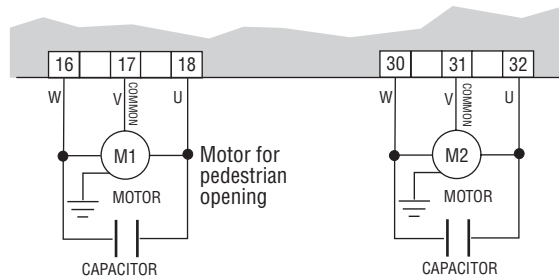
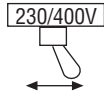
**Trimmer T1**

MOTOR RUN TIME OPEN / CLOSE FROM 5 TO 128s

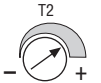
**Trimmer T2**

DWELL TIME from 5 to 128s

Flashing light:

Pre-flashing (Dip-Switch 4=ON): Once an Open pulse is given, after 3 seconds M1 motor starts. Once the gate is fully closed, the lamp goes on flashing for 3 more seconds.

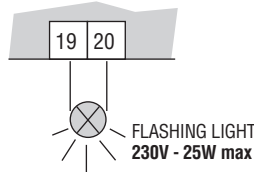
FLASHING LIGHT
230V - 25W max**DIP-SWITCH 4 and 7:**

ON: Pre-flashing
 4 OFF: No pre-flashing

ON: No flashing with the lamp on Dwell time. Automatic mode
 7 OFF: Flashing on Dwell time in Automatic mode option

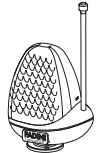
**Control board power supply:**

Fit the mains to the control board with a 0.03A high sensitivity, magnetic-thermal, differential circuit breaker. The board can be supplied 230V 50Hz $\pm 10\%$ Single-phase or 400V $\pm 10\%$ Three-phase. Both switches are to be set to the required voltage.

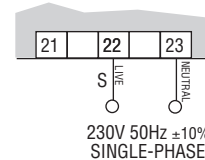
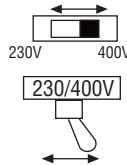
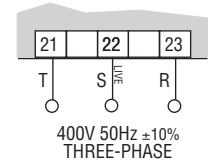
230V 50Hz $\pm 10\%$
SINGLE-PHASE400V 50Hz $\pm 10\%$
THREE-PHASE230 VOLT
400 VOLT

FUNCTIONS

Automatic / Semi-automatic:

Automatic cycle: On pulsing to Open the gate is operated to open, stops for a time equal to the dwell time as pre-set with T2 trimmer, after this time the gate is automatically operated to Close.

Semi-automatic Cycle: On pulsing to Open the gate is operated to Open and held in open position. A new pulse is needed for the gate to close.

**Trimmer T2**
DWELL TIME
from 5 to 128s**DIP-SWITCH 3**

ON= Automatic Closing
 3 OFF= No automatic closing
Semi-automatic mode

Deadman Control:

Open and Close operations are by "hold on switched" control (no relay self-holding is involved). The automation is to be attended and the command unit is required to be held switched to achieve gate operation. Any operation is stopped on releasing the button or key.

DIP-SWITCH 6

ON= Deadman Control Dip-switch 4=OFF and Dip-switch 3=OFF
 6 OFF= Normal operating mode

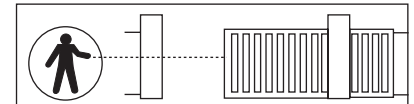
**Pedestrian Opening:**

With the gate in fully closed position, it is possible to open the gate for pedestrians by pulsing to Open with **Dip-Switch No.6=ON** terminals 3-4:

- a first Open pulse operates **Motor 1** to open
- a second pulse operates the other gate to Open

A pulse given to terminals 7 - 8 (Radio Contact) by the remote control always operates both gates.

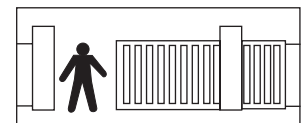
**Trimmer T3**From 3 to 30 s activated by any commanding pulse (even by remote control), superior to 2s to **M1 Motor****Radio out of service on Dwell time in Automatic Mode option:**

In this Mode, any pulse given by Radio remote control during the dwell time in Automatic mode option does not allow any operation with the system. DIP-SWITCH No.2=ON, No.3=ON and No.5=ON

ON: No gate travel reversing on Opening
 2 OFF: Any new pulse reverses gate travel

ON= Automatic Closing
 3 OFF= No Automatic Closing

ON: Step by step Stop in between
 5 OFF: Standard operating mode

Time clock:

How it works: Set the clock to the required time. On the set time the gate is operated to open and held open. No other operations can be achieved (not even by remote control) until the time set on the clock has expired. On expiring of the clock time and after the dwell time of the system, the gate is automatically operated to close.

Trimmer T3 is to be set on to zero, Dip-Switch No. 3=ON

**Trimmer T3**
T3 Trimmer. Pedestrian
to zero value**DIP-SWITCH No.3=ON Automatic Closing**

ON= Automatic Closing
 3 OFF= No automatic closing.
Semi-automatic option

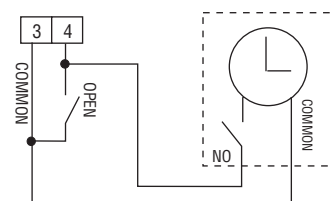

- **The limit switch contacts** are to be connected as shown in the diagram (pic. 13). 9 is in series with the voltage cut off microswitch No.1 (pic.9).

When Nyota 115 is on the first running test, and it is realized that the gate is operated in the wrong direction (for instance the gate fails to stop as the limit switch rod is pushed in the same direction), **reverse** the connections of the electric motor, by **changing over live 1 and live 2** (ie. terminal 16 with 18), and those of the **limit switches** (terminal 8 with 10) (pic.13) in the control box main board, **common 9 and 17** remain fixed (pic.14).

NOTE: IN CASE OF MOTOR FAILURE BECAUSE OF POWER SHORTAGE, ADD A **12.5 μ F CAPACITOR** IN PARALLEL TO THE ELECTRIC MOTOR LIVE 1 AND 2 (pic. 14).

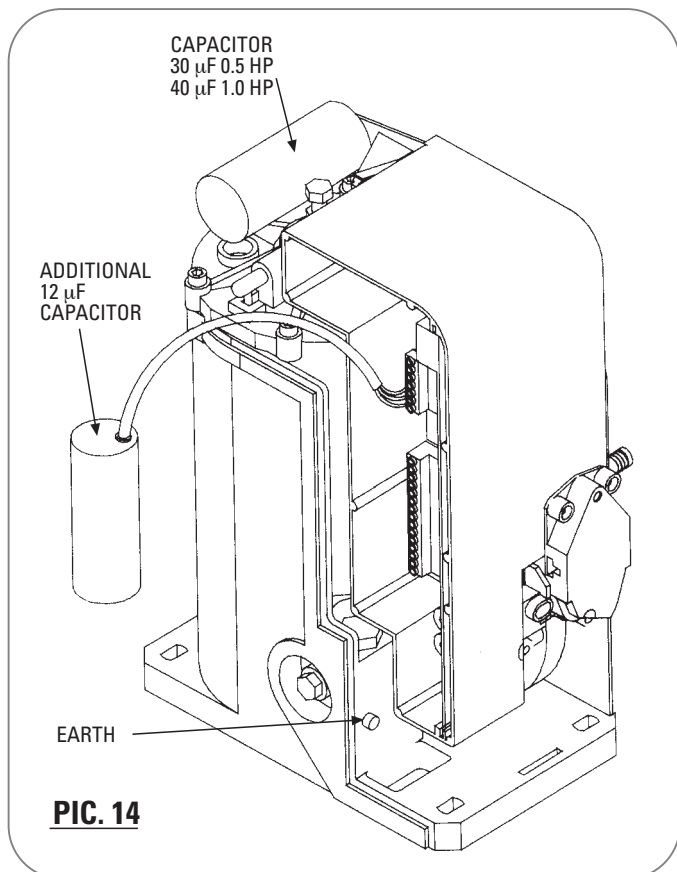

TORQUE CONTROL ADJUSTMENT

NYOTA 115 incorporates an adjustable torque control system in an oil bath, which can be adjusted to the gate weight. A 13 mm spanner can be used for adjusting operations (pic.15):

- 1) Press and hold the **retaining pin**
- 2) By means of a **13 mm spanner** unscrew the **locknut** (the pin will lock the main shaft)
- 3) Keep on holding the **retaining pin** pressed and tighten the **adjustment screw** (+ power) or unscrew it (- power)
- 4) Tighten the **nut** to lock the **adjustment screw** in the set position as required
- 5) Release the **retaining pin**.

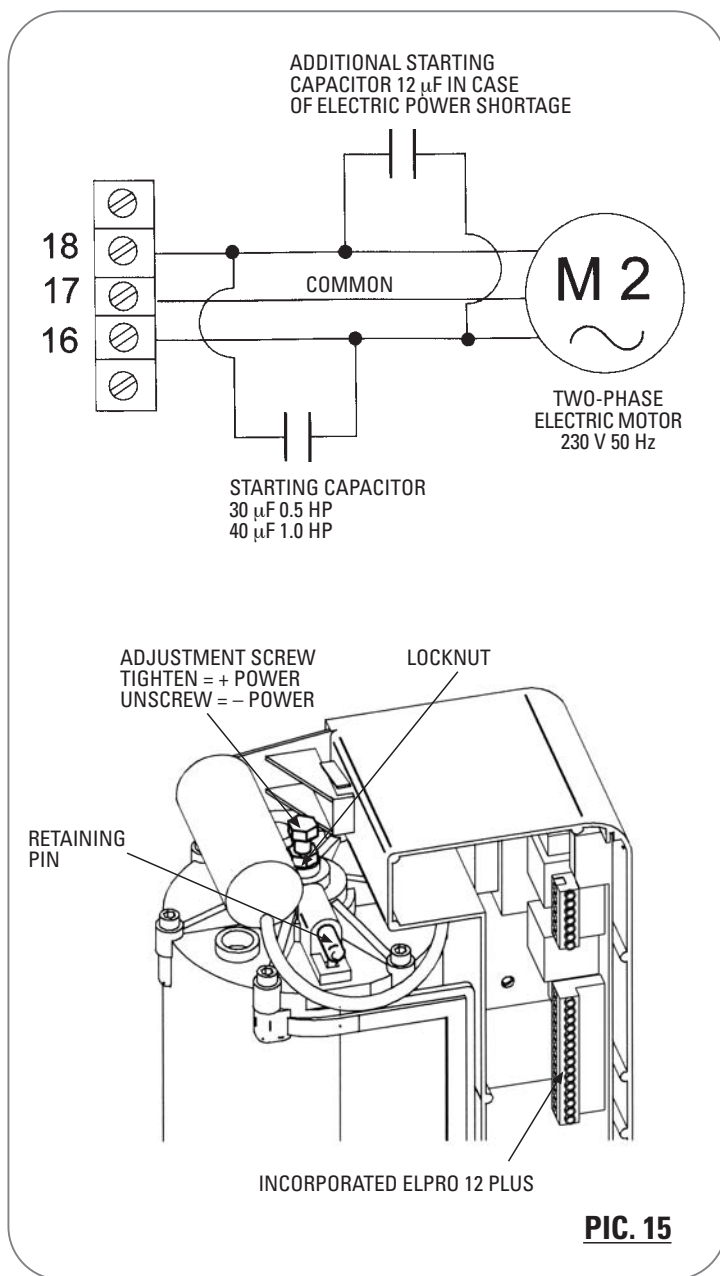
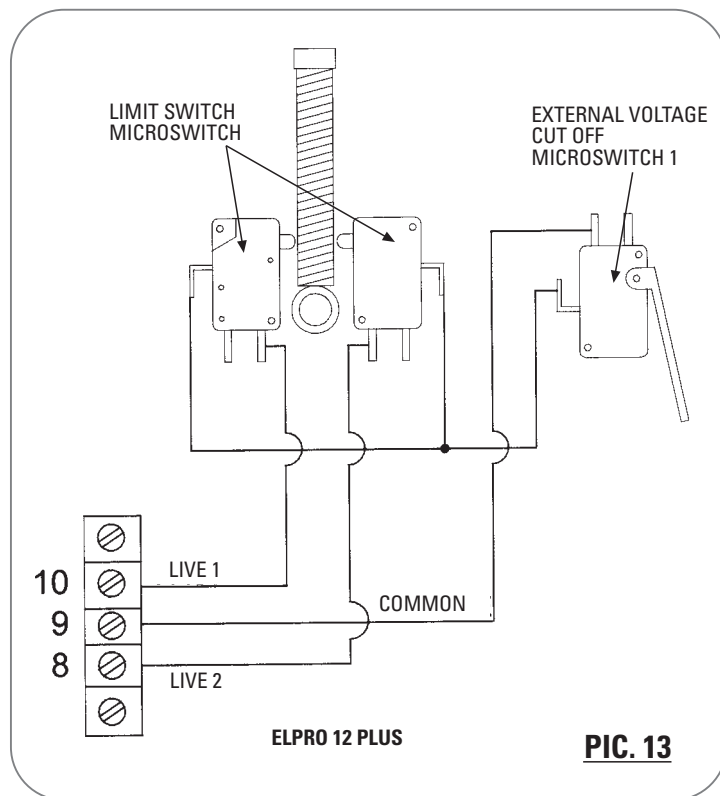

TECHNICAL SPECIFICATIONS NYOTA 115

ELECTRIC MOTOR

	SINGLE-PHASE	THREE-PHASE	SINGLE-PHASE	THREE-PHASE
Power output	0.37 KW (0.5 HP)	0.37 KW (0.5 HP)	0.73 KW (1 HP)	0.73 KW (1 HP)
Supply voltage	230 V	230/400 V	230 V	230/400 V
Frequency	50 Hz	50 Hz	50 Hz	50 Hz
Absorbed power	600 W	575 W	1'130 W	1'030 W
Absorbed current	3.2 A	2.1-1.2 A	5.7 A	3.7-2.2 A
Motor rotation speed	1'380 rpm	1'380 rpm	1'380 rpm	1'380 rpm
Capacitor	30 μ F		40 μ F	
Intermittent service	S5	S5	S5	S5

NYOTA 115 GEAR BOX

Rated torque	40 Nm	40 Nm	80 Nm	80 Nm
Gear ratio	1:32	1:32	1:32	1:32
Running speed	9.6 m/1'	9.6 m/1'	9.6 m/1'	9.6 m/1'
Oil temperature	-20°C +80°C	-20°C +80°C	-20°C +80°C	-20°C +80°C
Oil type	AGIP ROTRA THT - W80 - Kg 0.22	AGIP ROTRA THT - W80 - Kg 0.22	AGIP ROTRA THT - W80 - Kg 0.22	AGIP ROTRA THT - W80 - Kg 0.22
Protection standard	IP 557	IP 557	IP 557	IP 557
Weight Nyota 115	18.5 Kg	18 Kg	20 Kg	19.5 Kg
Max. gate weight	500 Kg	600 Kg	800 Kg	1'200 Kg

Duty cycle

25 s Open - 30 s Dwell - 25 s Close
 Time for one complete cycle: 80 s
 No. of complete cycles Open-Dwell-Close: 45/hour
 No. of complete cycles per year (8 hours' service per day): 131'000 cycles

ELPRO 10 PLUS CEI CONTROL PANEL

Power supply	230 / 400 V	Power transformer	20 VA
Voltage output	230 V - 25 W	Magnetic core	1.5 W / 0.5 thick.
Low voltage output	24 V - 10 W	Voltage	0-230 V
E.M. max. power output	1'100 W	Output	0-12-18-24 V
Line fuses	5 A	Frequency	50-60 Hz
Secondary fuses	1A - 630 mA	Insulation	4 Kv x 1'
Logic switching	Open-Stop-Close	Main switch	T215K mark SAA
Box dimensions	280x200x110	Contact rating	15A 250 VAC
Protection standard	IP 437		
Elesta relay marking	VDE-CSA-DEMCO-SEV		
	10 A 230 V		
	4 A 400 V		

FITTING ACCESSORIES FOR INSTALLING NYOTA 115

NYOTA 115 ELECTRO-MECHANICAL
TORQUE CONTROL IN OIL BATH BRONZE-STEEL COUPLING

E 13 RELEASE
SPANNER

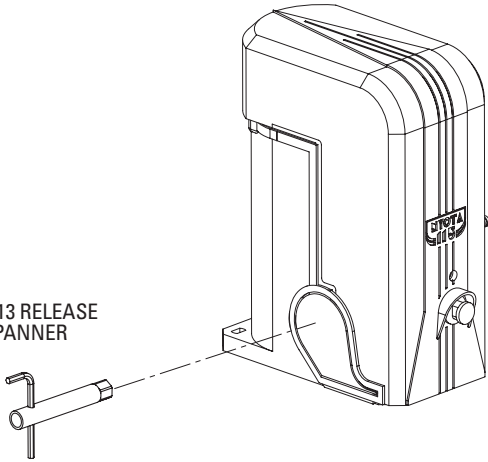

M8x40

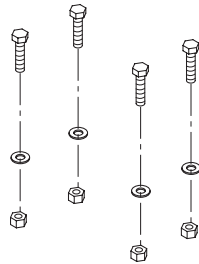

FIXING BASE PLATE
FOR CONCRETE
EMBEDDING

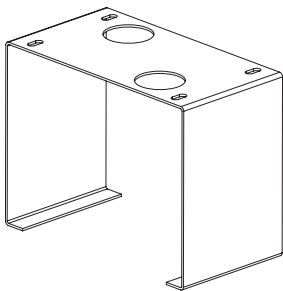

LIMIT SWITCH STRIKING
PLATES WITH FIXING SCREWS

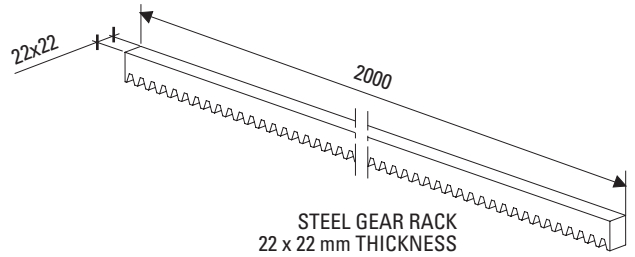
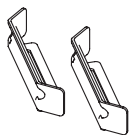

STEEL GEAR RACK
22 x 22 mm THICKNESS

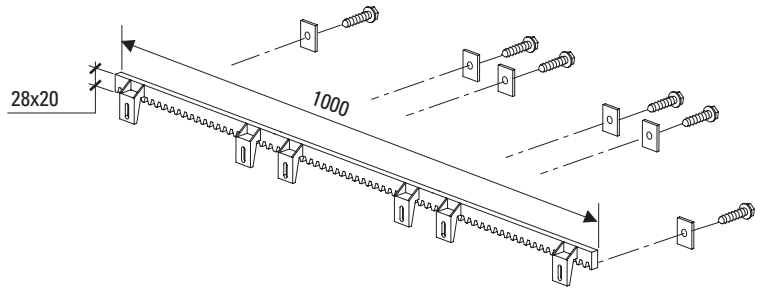

NYLON GEAR RACK 8 mm THICKNESS

M8 GEAR RACK FIXING SET

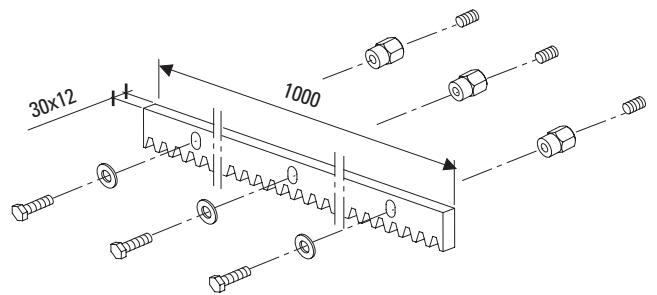

STEEL GEAR RACK WITH FIXING SLOTS
30 x 12 mm THICKNESS

MAGNETIC LIMIT SWITCH ONTO NYOTA 115 - Item No. 123

IMPORTANT: BEFORE FIXING THE SCREW, MAKE SURE THAT THE ELECTRIC WIRES ARE FITTED THROUGH THE HOLE IN THE MAGNETIC LIMIT SWITCH COVER

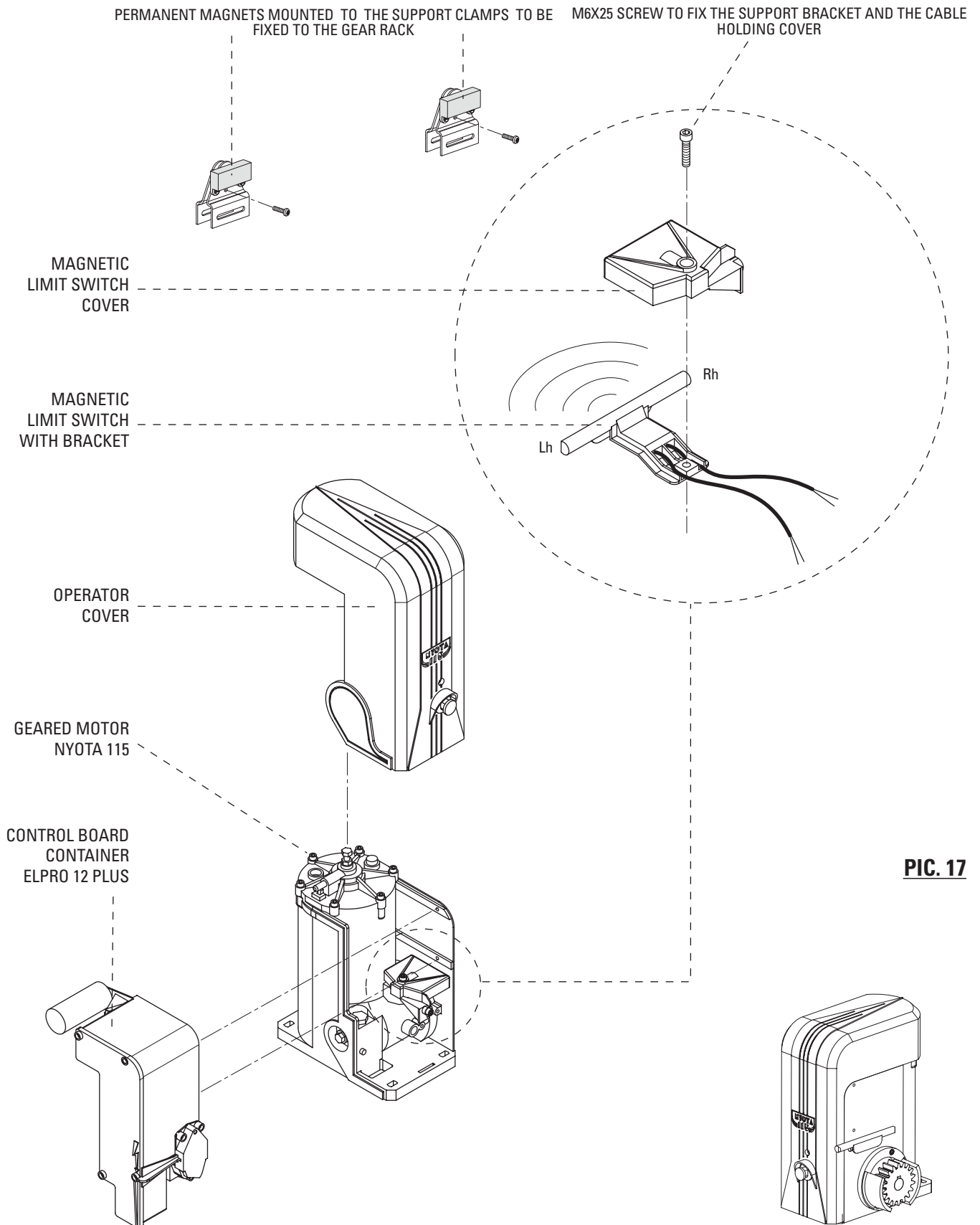

PIC. 17

The magnetic limit switch is fitted to the Nyota 115, and the permanent magnets are fitted to the gear rack moving along with the gate to the respective limit position on Opening and Closing cycles.

**30x12 GEAR RACK C/W FIXING EYES
MAGNET FIXING IS BY CLAMP**

PIC. 18

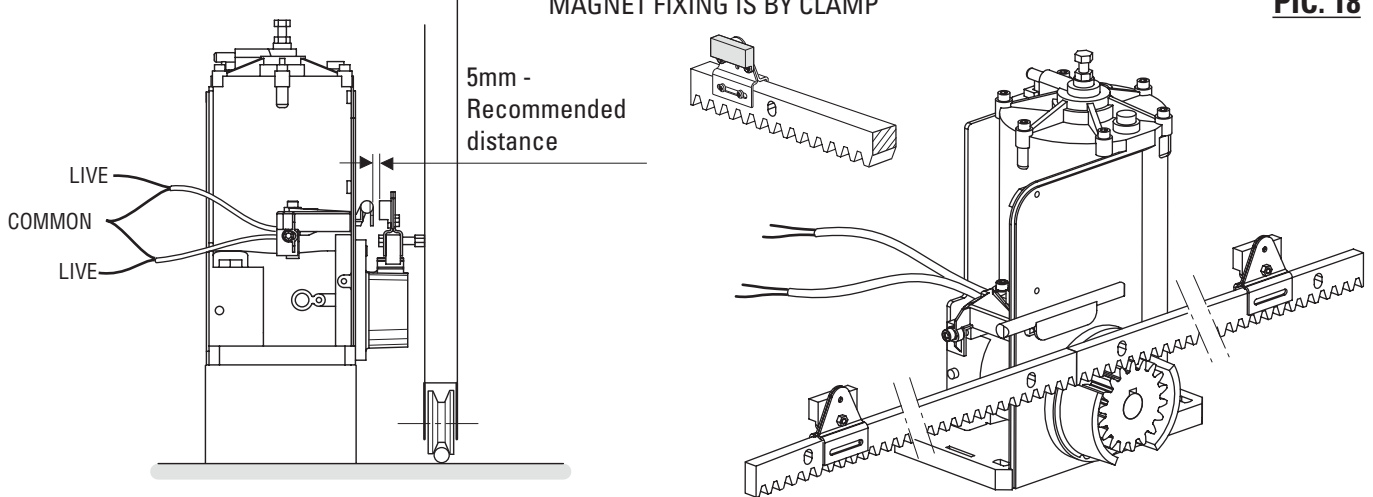

**28x20 NYLON GEAR RACK
MAGNET FIXING IS BY SCREWS**

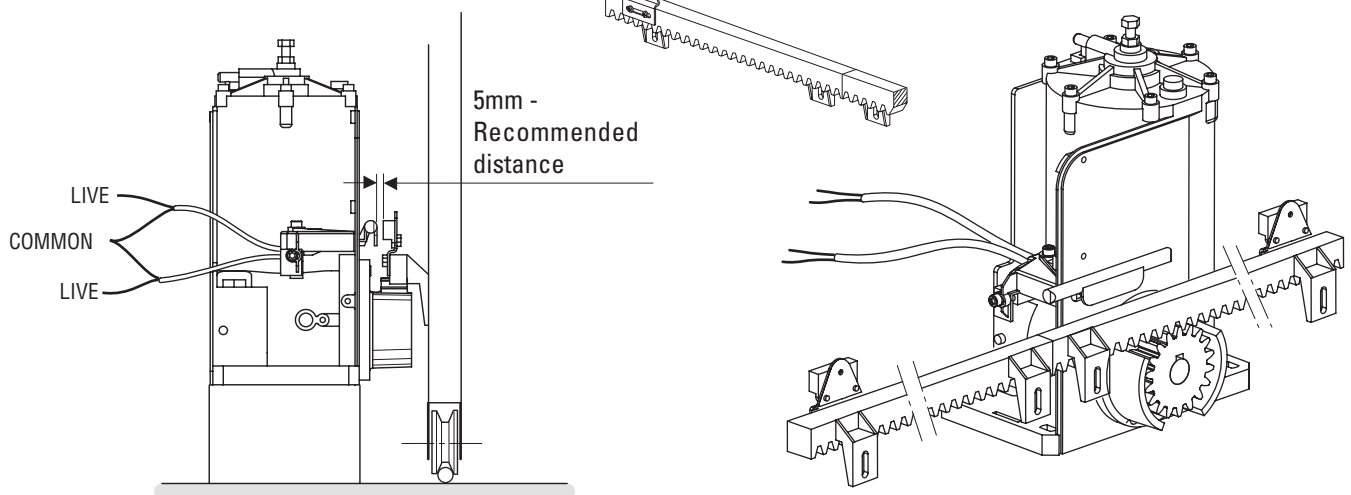

**22x22 STEEL GEAR RACK
MAGNET FIXING IS BY SCREWS**

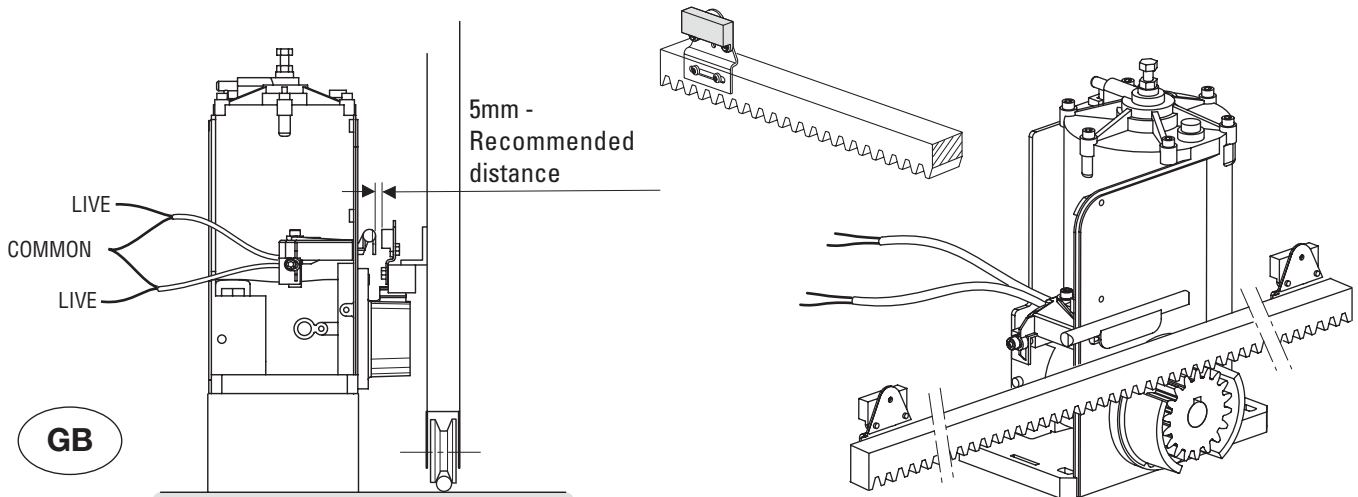

GB



FADINI
The gate opener
Made in Italy

Drwg. No. 1975

**APPLICATION OF THE VERSION NYOTA 115
WITH MAGNETIC LIMIT SWITCH**



**meccanica
FADINI**

NYOTA 115 OVERALL DIMENSIONS

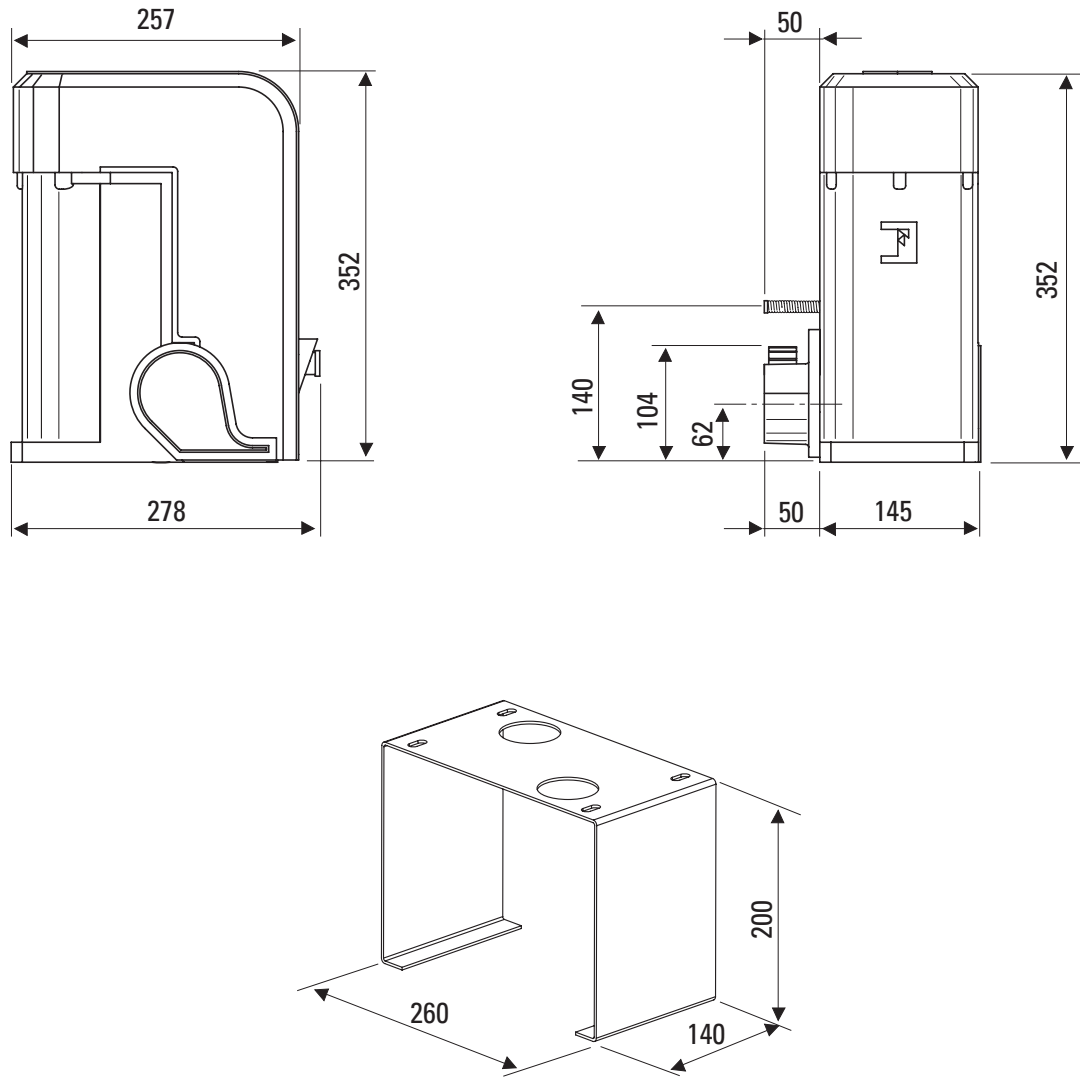

PIC. 19

NYOTA 115

ELECTRO-MECHANICAL SLIDING GATE OPERATOR

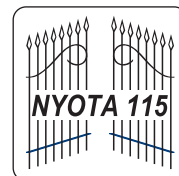

CHECKING AND MAINTENANCE:

To achieve an optimum performance and longer life of the equipment and in observance of the safety regulations, it is recommended that inspections and proper maintenance are made by qualified technicians to the whole installation ie. both the mechanical and electronic parts, as well as wiring.

- Mechanical parts: maintenance every 6 months approx.
- Electronic apparatus and safety equipment: maintenance every month approx.

IMPORTANT WARNING NOTES

- Before installing the equipment carry out a **Risk Analysis** and fit any required device in compliance with EN 12445 and EN 12453 Safety Norms.
- It is recommended to keep to the instructions in this booklet - make sure that the motor specifications as printed on the motor sticker conform to those of the mains.
- Dispose properly of the packaging materials such as cardboard, nylon and polystyrene through specialized companies.
- Should the operator be removed, **do not cut** the electrical cables, but properly remove them by loosening the pins in the terminal board.
- Switch off the mains switch before the cover of the motor terminal board is removed.
- All the equipment must be properly earthed by the yellow/green cable marked with the specific symbol.
- It is recommended to carefully read the regulations, advice and remarks in the book "Safety Norms".

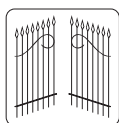

FADINI
the gate opener
Made in Italy

The growth of MECCANICA FADINI has always been based on the development of guaranteed products thanks to our "TOTAL QUALITY CONTROL" system which ensures constant quality standards, updated knowledge of the European Standards and compliance with their requirements, in view of an ever increasing process of improvement.

The "CE" mark certifies that the operator conforms to the essential requirements of the European Directive art. 10 EEC 73/23, in relation to the manufacturer's declaration for the supplied items, in compliance with the body of the regulations ISO 9000-UNI EN 29000. Automation in conformity to EN 12453, EN 12445 safety standard.

CE EUROPEAN MARK CERTIFYING CONFORMITY
TO THE ESSENTIAL REQUIREMENTS OF THE
STANDARDS 98/37/EC

- DECLARATION OF CONFORMITY
- SAFETY NORMS
- EN 12453, EN 12445 STANDARDS
- CEI EN 60204-1 STANDARDS
- WARRANTY CERTIFICATE ON THE CUSTOMER'S REQUEST



AUTOMATIC GATE MANUFACTURERS

Via Mantova, 177/A - 37053 Cerea (Verona) Italy
Tel. 0442 330422 r.a. - Fax 0442 331054
e-mail: info@fadini.net - www.fadini.net

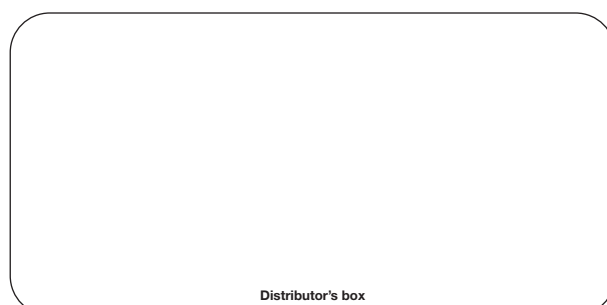

The manufacturers reserve the right to change the products without any previous notice