



FADINI
l'apricancello
Made in Italy

I

Elpro 14 PLUS

PROGRAMMATORE A
MICROPROCESSORE MONOFASE-TRIFASE
PER CANCELLI A DOPPIA ANTA
SCORREVOLE
LIBRETTO DI ISTRUZIONI

- FUNZIONE PASSO PASSO
- UOMO PRESENTE
- APERTURA PEDONALE
- SPIA DI SEGNALAZIONE DELLO STATO DELL'AUTOMAZIONE
- POSSIBILITA' DI ESCLUDERE LAMPEGGIANTE IN PAUSA
- LUCE DI CORTESIA TEMPORIZZATA
- FUNZIONE OROLOGIO

pag. 1,2,3

GB

Elpro 14 PLUS

SINGLE-/THREE-PHASE CONTROL UNIT FOR
DOUBLE SLIDING GATES,
FITTED WITH MICROPROCESSOR
INSTRUCTIONS MANUAL

- STEP BY STEP
- DEAD MAN CONTROL
- PEDESTRIAN OPENING
- GATE STATUS INDICATION
- NO FLASHING LIGHT OPTION ON DWELL TIME
- TIME-SWITCHED COURTESY LIGHT
- TIME CLOCK OPTION

page 1,4,5

F

Elpro 14 PLUS

PROGRAMMATEUR A MICROPROCESSEUR
MONOPHASE-TRIPHASE POUR PORTAILS
COULISSANTS A DEUX VANTAUX
NOTICE D'INSTALLATION

- FONCTION PAS-PAS
- HOMME MORT
- POSSIBILITE D'EXCLURE LA LAMPE CLIGNOTANTE PENDANT L'ARRET
- VOYANT DE SIGNALISATION DE L'ETAT DE L'AUTOMATISATION
- OUVERTURE PIETONS
- LAMPE D'ECLAIRAGE TEMPORISEE
- FONCTION HORLOGE

page 1,6,7

D

Elpro 14 PLUS

Seite 1,8,9

E

Elpro 14 PLUS

PROGRAMADOR CON MICROPROCESADOR
MONOFASICO - TRIFASICO PARA VERJAS
DESIZANTES DE DOS HOJAS
FOLLETO DE INSTRUCCIONES

- FUNCIONAMIENTO PASO A PASO
- HOMBRE PRESENTE
- LÁMPARA TESTIGO QUE SEÑALA EL ESTADO DEL AUTOMATISMO
- ABERTURA PARA PASO DE PEATONES
- POSIBILIDAD DE EXCLUIR EL DESTELLADOR EN PAUSA
- LUZ AUXILIAR TEMPORIZADA
- FUNCIÓN RELOJ

pág. 1,10,11

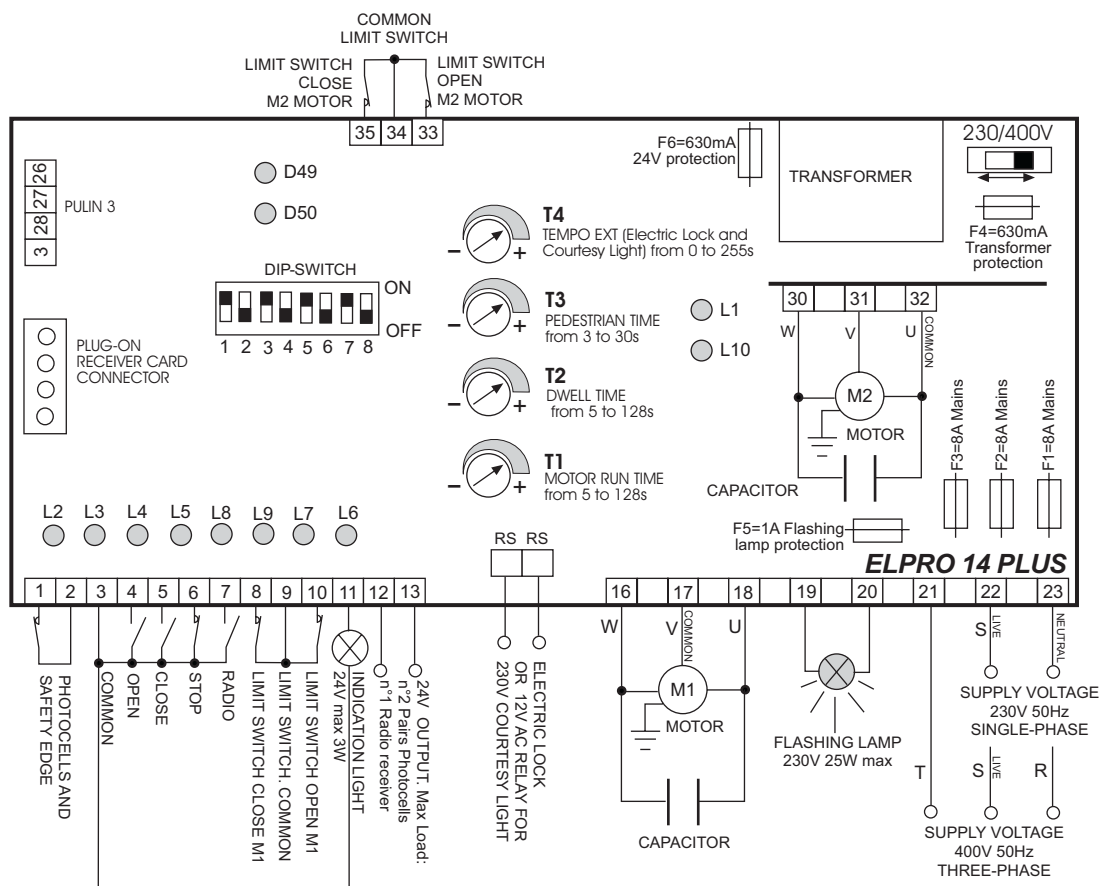

The electronic control panel Elpro 14 Plus, new generation, is designed to operate the sliding gate operators. Power supply is 230/400V single- and three-phase. It is built in full compliance with BT 93/68/CE Low Voltage and EMC 93/68/CE Electro-Magnetic Compatibility Regulations. Fitting operations are recommended to be carried out by a qualified technician in conformity to the existing safety standards. The manufacturing company declines any responsibility for incorrect handling and applications; also, it reserves the right to change or update the control panel any time.

IMPORTANT:

- The control unit is to be fitted in a sheltered place inside a suitable enclosure.
 - Fit the mains to the control panel with a 0.03A high performance magnetic-thermal circuit breaker
 - Use 1.5 mm² section wires for voltage supply, electric motor and flashing lamp for distances not superior to 50 m; and 1mm² section wires for the limit switches and the accessories
 - Bridge terminals 1 and 2 if no photocells are required
 - Bridge terminals 3 and 6 if no key- or push-button switches are required
- N.W:For applications such as light switching, CCTV etc. use solid state relays to prevent the microprocessor from being affected

Dip-Switch:

- 1 = ON Photocells. Stop on opening
- 2 = ON Radio. No reverse on opening
- 3 = ON Automatic closing
- 4 = ON Preflashing activated
- 5 = ON Radio. Step by step. Stop in between
- 6 = ON Dead Man Control (Dip 4=OFF n Dip 3=OFF)
- 7 = ON No lamp flashing during Dwell time on Automatic Mode
- 8 = OFF, No pre-set function

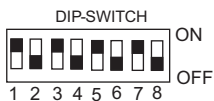

Trouble shooting:

- Check supply voltage, it must be 230V or 400V - 50 Hz
- Check the fuses
- Check photocell contact, it must be NC.
- Check that all other contacts are NC
- Check that no voltage drop occurs from the control unit to the electric motor

Status indication LEDs:

- L1 = 230V 50 Hz power supply. A light
- L2 = Photocells, if obstructed light goes off
- L3 = Open. Light goes on whenever an Open pulse is given
- L4 = Close. Light goes on whenever a Close pulse is given
- L5 = Stop. It goes off on pulsing Stop
- L6 = Radio control. It goes on by pressing a transmitter button

- L7 = Gate status. It flashes on gate moving
- L8 = Limit switch Close, M1 motor, off when gates are closed
- L9 = Limit switch Open, M1 motor, off when gates are open
- L10 = It stays on as long as the time set on T4
- D49 = Limit switch Close, M2 motor, off when gates are closed
- D50 = Limit switch Open, M2 motor, off when gates are open

LOW VOLTAGE ELECTRICAL CONNECTIONS

Photocells and Safety Edge:

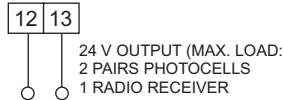
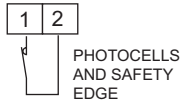

DIP-SWITCH 1:

- ON: Photocells stop gate on opening, reverse it on closing once obstacle is removed
- 1 OFF: Photocells do not stop gate on opening, reverse it on closing if obstructed

Keyswitch:

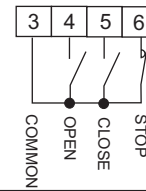

Limit switch:

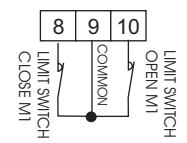

Radio Receiver:

- Open/Close (standard)
- Any new pulse reverses gate travel
- Step by Step



DIP-SWITCH 2 n 5 (NEVER set both of them to ON at the same time):

- ON: Gate travel is not reversed on opening
- 2 OFF: Any pulse reverses gate travel

- ON: Step by step. Stop in between
- 5 OFF: Standard Operating Mode as pre-set

Push button switch Pulin3:

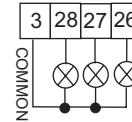

Status indication LEDs of the Open - Stop - Close buttons

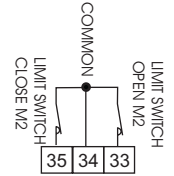

24V 3W Indication Light:

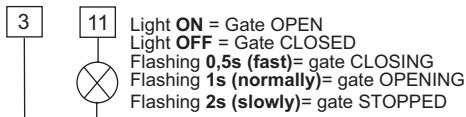

Light **ON** = Gate OPEN
Light **OFF** = Gate CLOSED
Flashing **0.5s (fast)** = gate CLOSING
Flashing **1s (normally)** = gate OPENING
Flashing **2s (slowly)** = gate STOPPED

Courtesy Light:

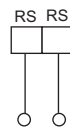

Connect a 12VAC relay (T4 from 2s to 255s) to operate a 230V lamp

Electric lock:

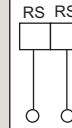

Set T4 Trimmer to the lowest value, the electric lock is excited for 2 seconds

ELECTRIC POWER CONNECTIONS

Single- and Three-phase Motors:

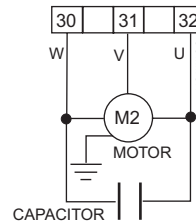
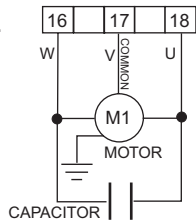
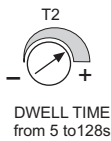

Flashing lamp:

DIP-SWITCH 4 n 7

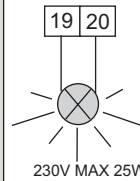

- ON: Pre-flashing
- OFF: No Pre-flashing

- ON: Lamp is out of service during Dwell time. Automatic Mode
- 7 OFF: Lamp to flash during Dwell Time. Automatic mode

OPERATING MODES

Automatic/semi-automatic:

Automatic Operation: On pulsing to Open the gate is operated to open, it stops for a time as pre-set on T2, on expiring of the Dwell time the gate is automatically closed.

Semi-automatic operation: On pulsing to Open the gate opens and stops in open position. A second pulse is needed to close the gate.



DIP-SWITCH 3

- ON= Automatic Closing
- 3 OFF= No Automatic. Closing by pulse

Dead Man Control:

Open and Close operations are by "hold on switched" control (no relay self-holding is involved). The automation is to be attended and the command unit is required to be held switched to achieve gate operation. Any operation is stopped on releasing the button or key.

DIP-SWITCH 6

- ON= Dead Man Control. Dip-switch 4=OFF and Dip-switch 3=OFF
- 6 OFF= Standard Operating Mode as pre-set

Voltage Supply:

230V 400V

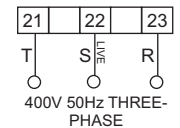
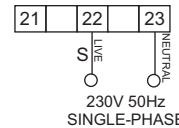

Pedestrian Opening:



From 3 up to 30 s. It can be activated by any pulse (remote control as well) that is longer than 2s

No Radio Receiver Action during Dwell Time on Automatic Mode:

With this setting the Radio Receiver is out of service during the Dwell Time on Automatic Mode. No operation can be achieved by remote control., DIP-SWITCH N°2=ON, N°3=ON and N°5=ON

- ON: No gate travel reversing on Opening
- 2 OFF: Any pulse reverses gate travel

- ON= Automatic Closing
- 3 OFF= No automatic Closing

- ON: Step by Step. Stop in between
- 5 OFF: Standard Operating Mode

Time Clock:

How it works: Set the clock to the required time. On the set time the gate is operated to open and held open. No other operations can be achieved (not even by remote control) until the time set on the clock has expired. On expiring of the clock time and after the dwell time of the system, the gate is automatically operated to close. Trimmer T3 is to be set on to zero, Dip-Switch N°3=ON and N°7=ON



DIP-SWITCH N°3=ON Automatic Closing

- ON= Automatic Closing
- 3 OFF= No Automatic Closing. A pulse is needed to close

DIP-SWITCH N°7=ON Lamp out of service on Dwell Time

- ON: Lamp out of service during Dwell Time on Automatic Mode
- 7 OFF: Lamp to flash during Dwell Time on Automatic Mode

