

Elpro·10 CEI SLIDING GATES – THREE-PHASE/SINGLE-PHASE

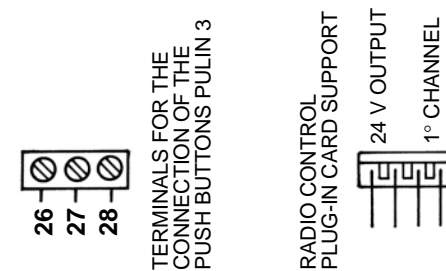

- NO PRE-FLASHING/PRE-FLASHING
- AUTOMATIC/SEMI-AUTOMATIC
- REMOTE CONTROL: NO REVERSE TRAVEL/REVERSE
- PHOTOCELLS: STOP DURING OPEN/NO STOP DURING OPEN-REVERSE DURING CLOSE

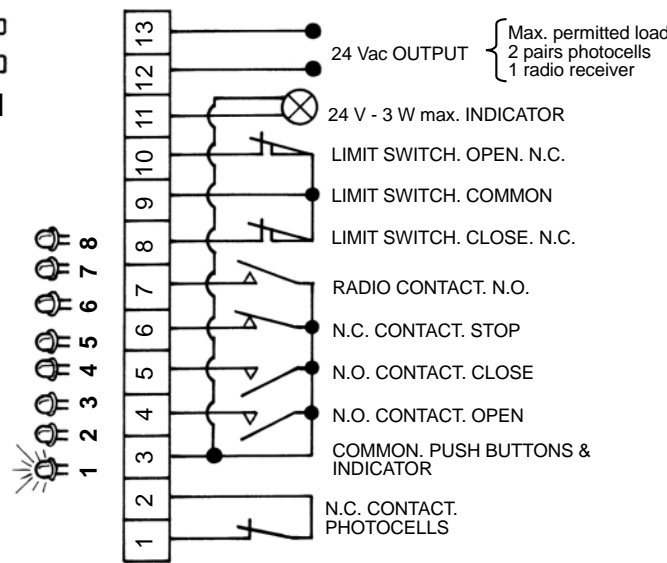
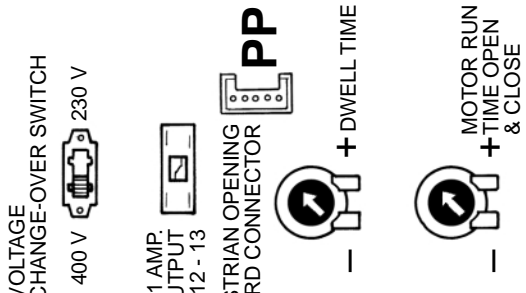
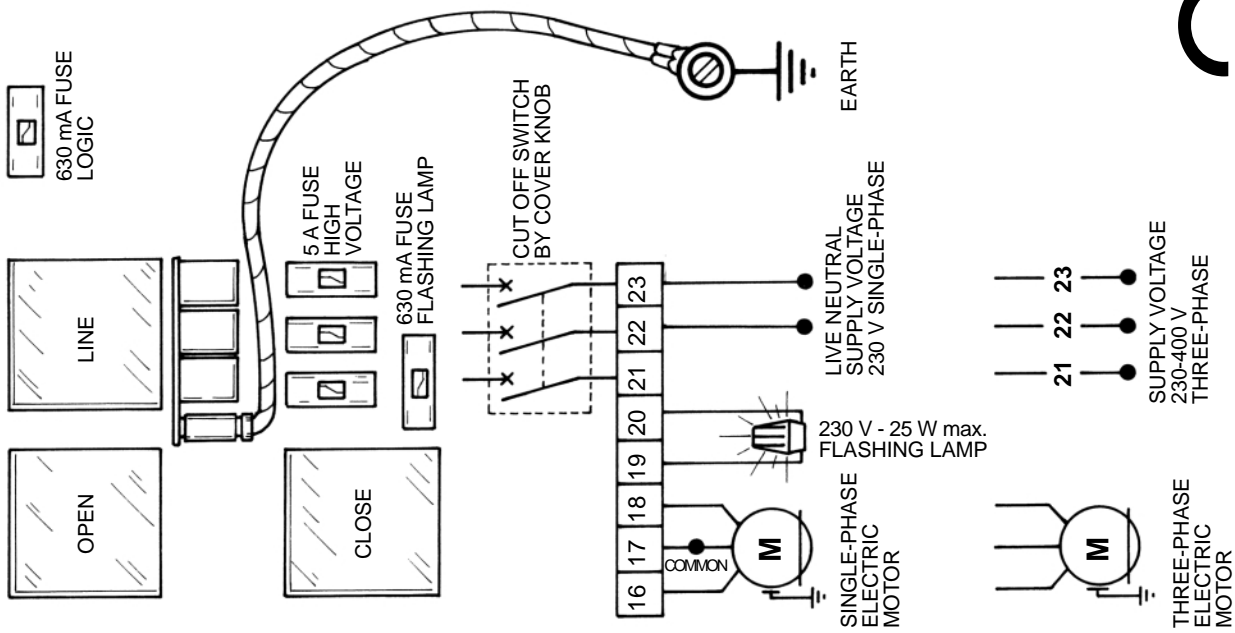
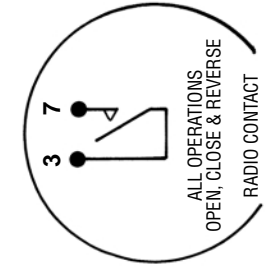

N. W.: for special applications, ie. to switch on lights - CCTV etc....
SOLID STATE RELAYS are recommended to be used only.
Standard relays would affect the micro-processor.

N.W.: THIS PANEL IS TESTED TO OPERATE GATES ONLY THROUGH FADINI ACCESSORIES. NO GUARANTEE FOR ACCESSORIES OF OTHER MAKE OR SPECIAL APPLICATIONS.

Should more pairs of photocells be required than the recommended quantity, fit an auxiliary transformer outside the control box.



Elpro·10 CEI

FEATURES OF THE ELECTRONIC PROGRAMMER FOR SLIDING GATES

All the electrical connections are to be made as per the following instructions and diagrams. Supply the terminals 21-22-23 with 230-400 V, 50 Hz, three-phase voltage. The "red led" No. 1 switches on and stays on as long as the board is properly supplied. Set the timer "MOTOR RUN. OPEN & CLOSE" so that the running time of the motor is longer than the actual travel of the gate. Set the timer "DWELL" - i.e. the interval between open and re-close - so that you can meet the required interval of time.

LOGIC OF THE ELECTRONIC PROGRAMMER: When a pulse is given, the flashing light switches on. After three seconds the motor starts. During the interval before re-closing, the light stays on. When the gate has fully re-closed, the light keeps on flashing for three more seconds and then switches off automatically.

The 3 second interval (pre-flashing) which precedes the actual start of the motor can be eliminated by means of the DIP-SWITCH "B" No. 4.

LED No. 1: It switches on when voltage is supplied.

LED No. 2: "PHOTOCELLS". Normally on. It switches off when the photocells are obstructed.

LED No. 3: "OPEN". It switches on when the respective switch is activated.

LED No. 4: "CLOSE". It switches on when the respective switch is activated.

LED No. 5: "STOP" Normally on. It switches off when the respective switch is activated.

LED No. 6: "LIMIT SWITCH. CLOSE". It switches off when the gate is fully closed.

LED No. 7: "LIMIT SWITCH. OPEN". It switches off when the gate is fully open.

LED No. 8: "RADIO". It switches on whenever a pulse is given, either through remote control, keyswitch or push buttons.

FUNCTIONS OF DIP-SWITCH "B"

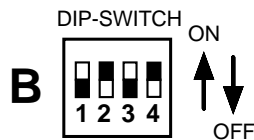

- 1 - ON: PHOTOCELLS. STOP DURING "OPEN" CYCLE
OFF: PHOTOCELLS. NO STOP DURING "OPEN" CYCLE
- 2 - ON: REMOTE CONTROL. NO REVERSE TRAVEL
OFF: REMOTE CONTROL. REVERSE TRAVEL
- 3 - ON: AUTOMATIC RE-CLOSING
OFF: NO AUTOMATIC RE-CLOSING
- 4 - ON: NO PRE-FLASHING
OFF: PRE-FLASHING

1) It is advisable not to expose the control box directly to weather conditions. If mounted outside, a suitable enclosure is recommended to protect it from sunshine and rain.

2) Earth the equipment by using the terminal fitted to the box, bottom right-hand side.

3) Bridge terminals 1 - 2 if you do not require any photocells.

4) Should two sets of photocells be required, these are to be series connected to terminals 1 - 2, contact normally closed.

5) Bridge terminals 3 - 6 if you do not require any keyswitch or push buttons.

6) Fit the mains to the control box with a high sensitivity, differential, magnetic-thermal switch, 0.03 Amps.

7) NOTE WELL

FAULT FINDING:

- Check supply voltage with a tester: it must be 230-400 V, three-phase.
- Check the high voltage fuses.
- Check if the photocell contacts are normally closed.
- Check voltage from the control box to the electric motor: power might have dropped.
- Check the fuse LOGIC.

- The section of the electric cables to the motor must not be less than 1.5 mm².

- To allow a sliding gate to open partially for pedestrians, pulse the N.O. push button that is connected to the respective terminals on the pedestrian opening card. Adjust the span of the pedestrian opening through the provided potentiometer "P" to meet the site requirements. DIP - switch - B - N° 3 set to "ON" automatic mode: the gate runs to closed after the time set with the main PC board potentiometer, ie. (+ DWELL). - You can manually pulse to close either by push button or remote control.

* 24 V ~ output. Terminals 12-13. It can supply power for 2 pairs of photocells plus 1 radio receiver.

Terminal 11 provides a power output for a lamp. 24 V - 3 W max.

Flashing lamp output. Terminals 22-23. Maximum available power 25 W max.

OPTIONAL PEDESTRIAN
OPENING P.P. CARD TO FIT
THE P.P. CONNECTOR

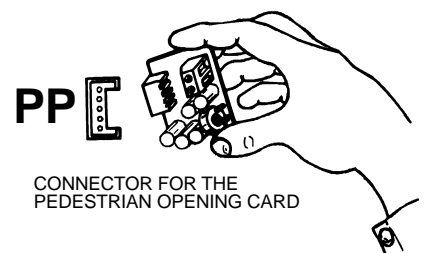

Drwg. No. 2442



meccanica
FADINI
s.n.c.

AUTOMATIC GATE MANUFACTURERS

Via Mantova, 177/A - 37053 Cerea (Verona) Italy

Tel. 0442 330422 r.a. - Fax 0442 331054

e-mail: info@fadini.net - www.fadini.net



FADINI
the gate opener
Made in Italy